



Categories

LED RGB Video Light

LED Light

DJI RONIN S ACCESSORIES

Camera Gimbal Accessories

PRO VIDEO GEAR

GIMBAL MAGIC ARM

OSMO ACTION

OSMO POCKET

Smartphone Gimbal

Battery & Charger

HD MONITOR

Camera Tripod & Monopod

DJI Drone Accessories

NECESSARY VIDEO KITS

LED RGB Video Light

Home > LED RGB Video Light

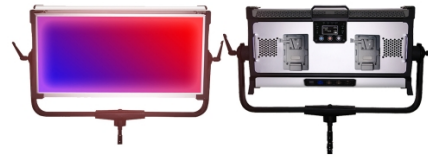

**S300**

300W RGB LED Panel Soft Light

**300W Full Color RGB LED Panel Soft Light 2800-9990k APP /DMX Control Dimming with 12 Color Effect PK ARRI S60**

Item No.: S300

ARRI S60 soft light is good but expensive, is there any high cost-performance option? S300 RGB LED Panel Soft Light developed by DigitalFoto Solution Limited is the choice.

INQUIRY

PDF Format



Description

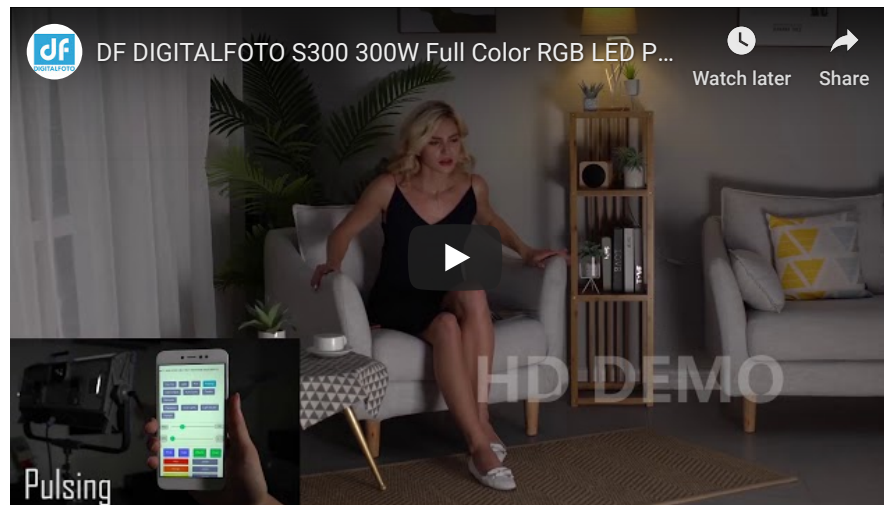

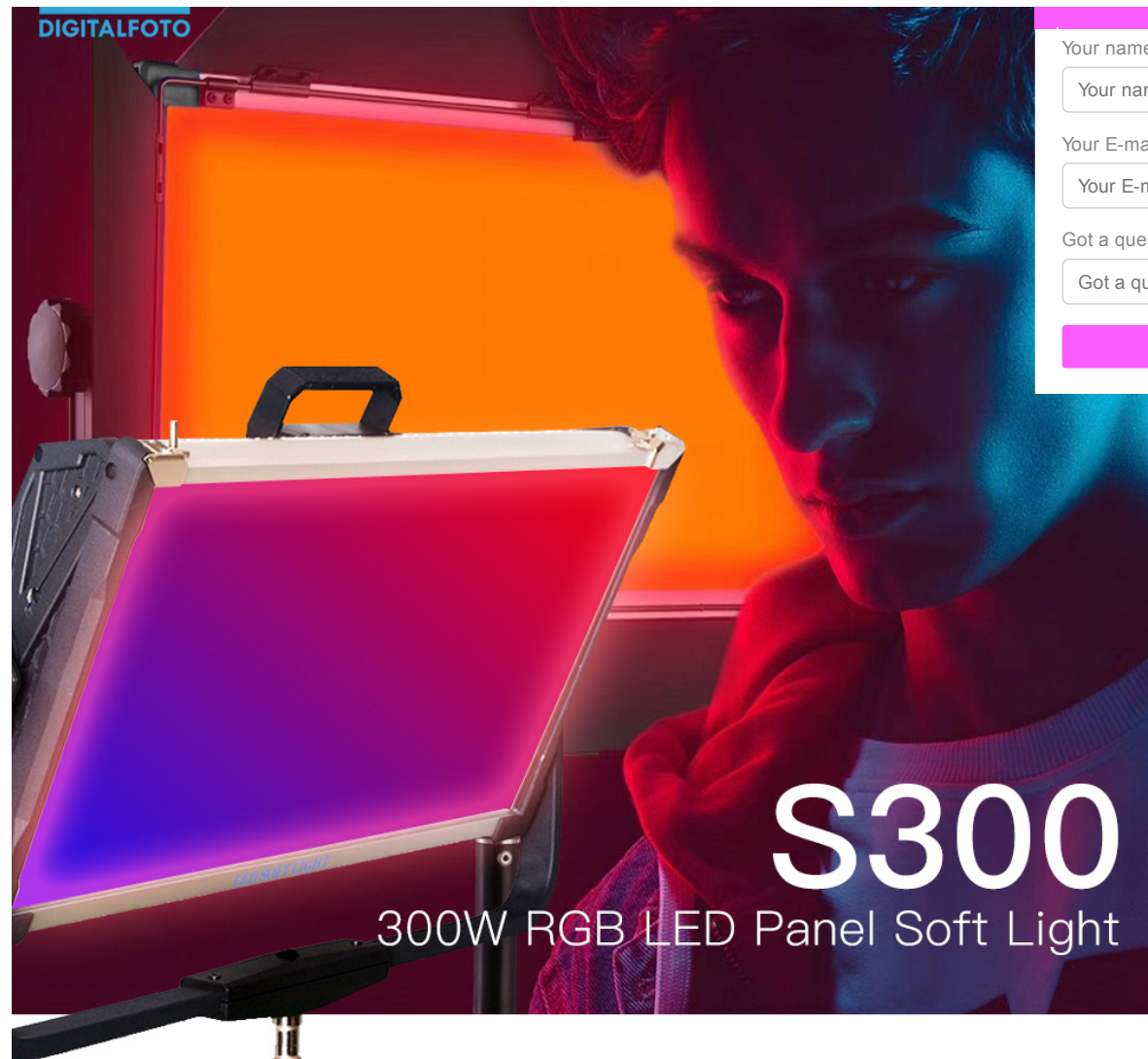

Your name\*:

Your E-mail\*:

Got a question?\*

Send

ARRI S30 soft light is good but expensive, is there any high cost-performance option?

S300 RGB LED Panel Soft Light developed by DigitalFoto Solution Limited is the choice.

SPECIFICATION

Model	S300							
Power	300W							
Lumen	30000							
Color Temperature	2800K-9990K±300K							
CRI	≥95							
Color	0-360° Saturation 0-99% Color Change							
Color Effect	12							
LED Illumination Angle	120°							
Control Mode	Dimming、Controller、APP、DMX							
Remote Control Distance	30m							
Working Voltage	AC 110~220V DC 26V							
Net Weight	12.2KG							
	Color Temperature							
		2800K	3200K	5600K	10000K	Red	Green	Blue
	Lumen							
	Distance							
0.5m		26675lux	27339lux	30150lux	26476lux	6667lux	14131lux	3078lux
1m		9294lux	9580lux	10622lux	9400lux	2288lux	5046lux	1100lux
2m		2723lux	2792lux	2940lux	2716lux	645lux	1410lux	317lux
5m		510lux	521lux	572lux	504lux	136lux	267lux	60lux

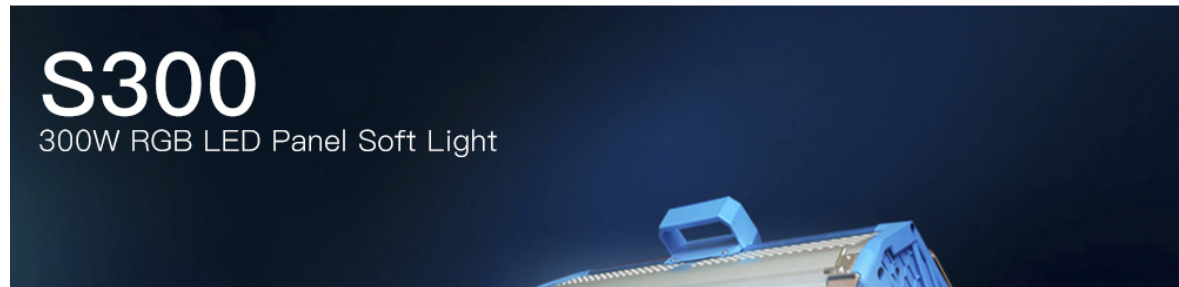

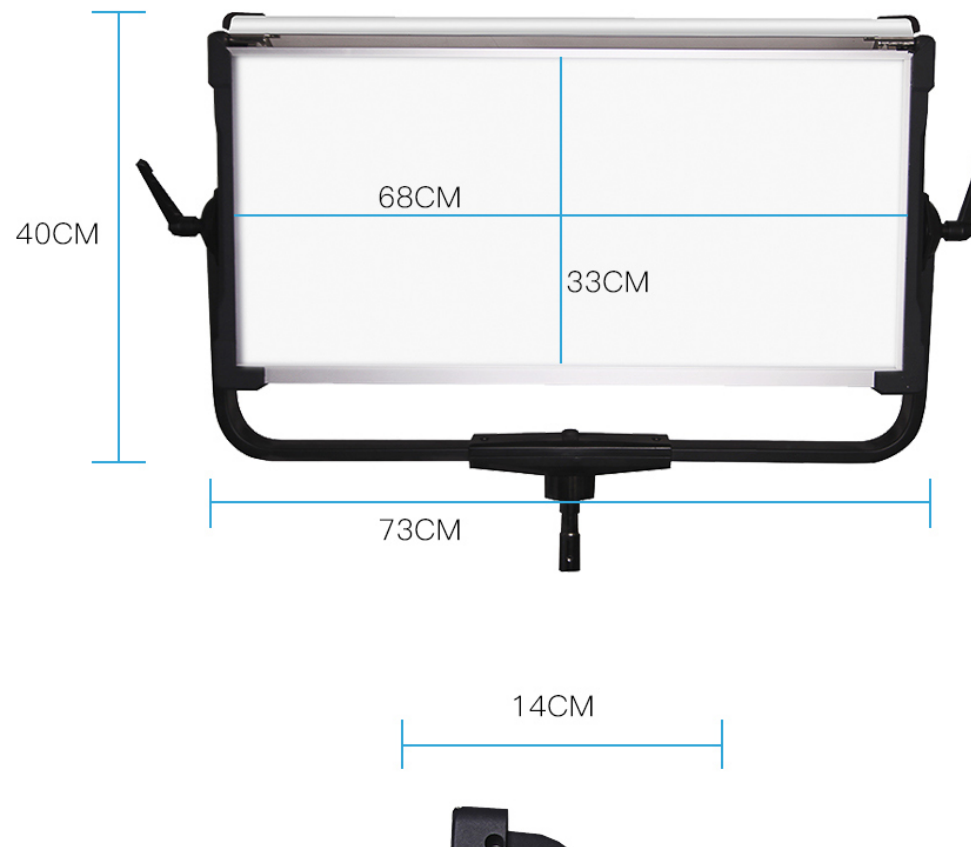





## DETAILS

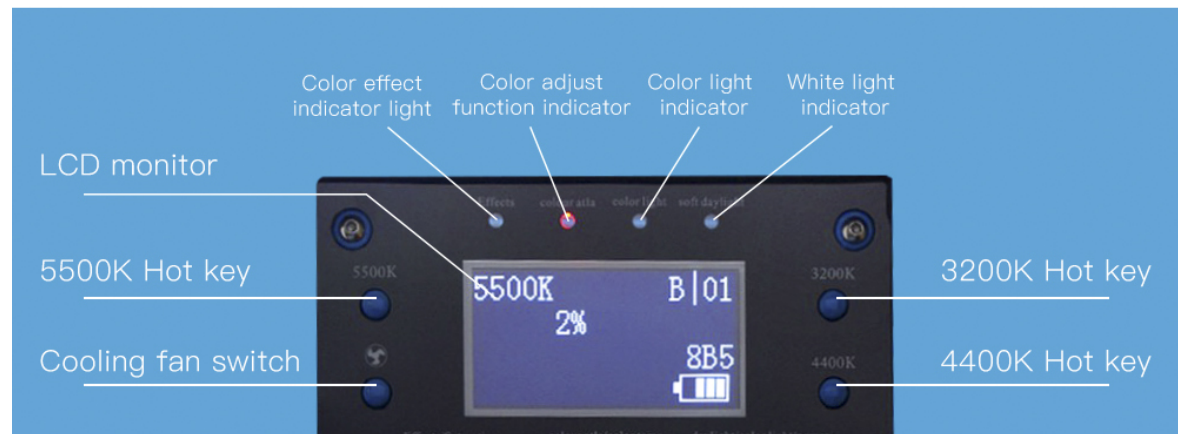

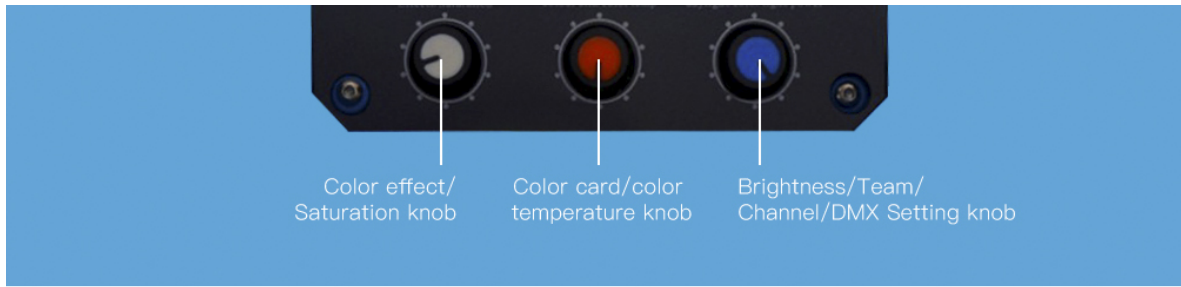

Angle control knob

Battery Plate

Soft plate lock

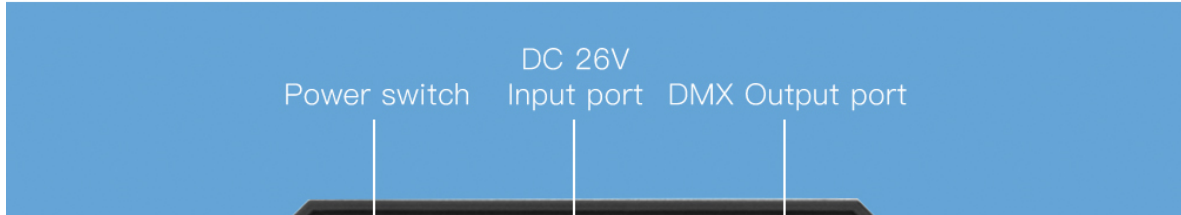



# ADVANTAGE



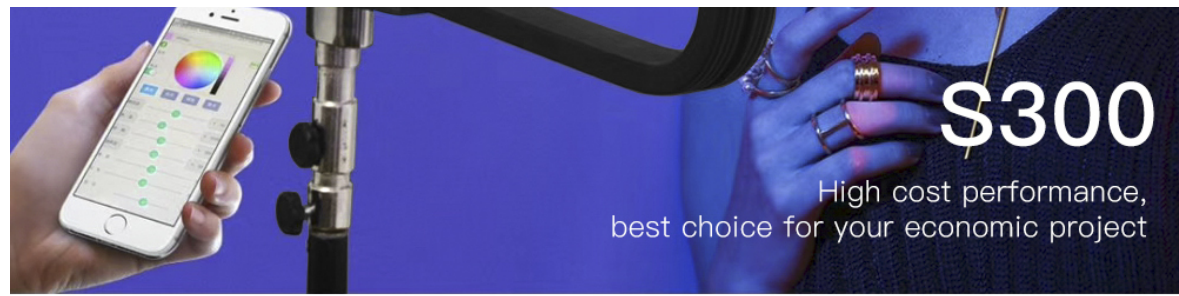

Designed with RGBW four LED patch combinations, high efficiency, energy saving and low light loss and no fake power





Support 26V high power supply



Built in cooling fan,fast heat dissipation

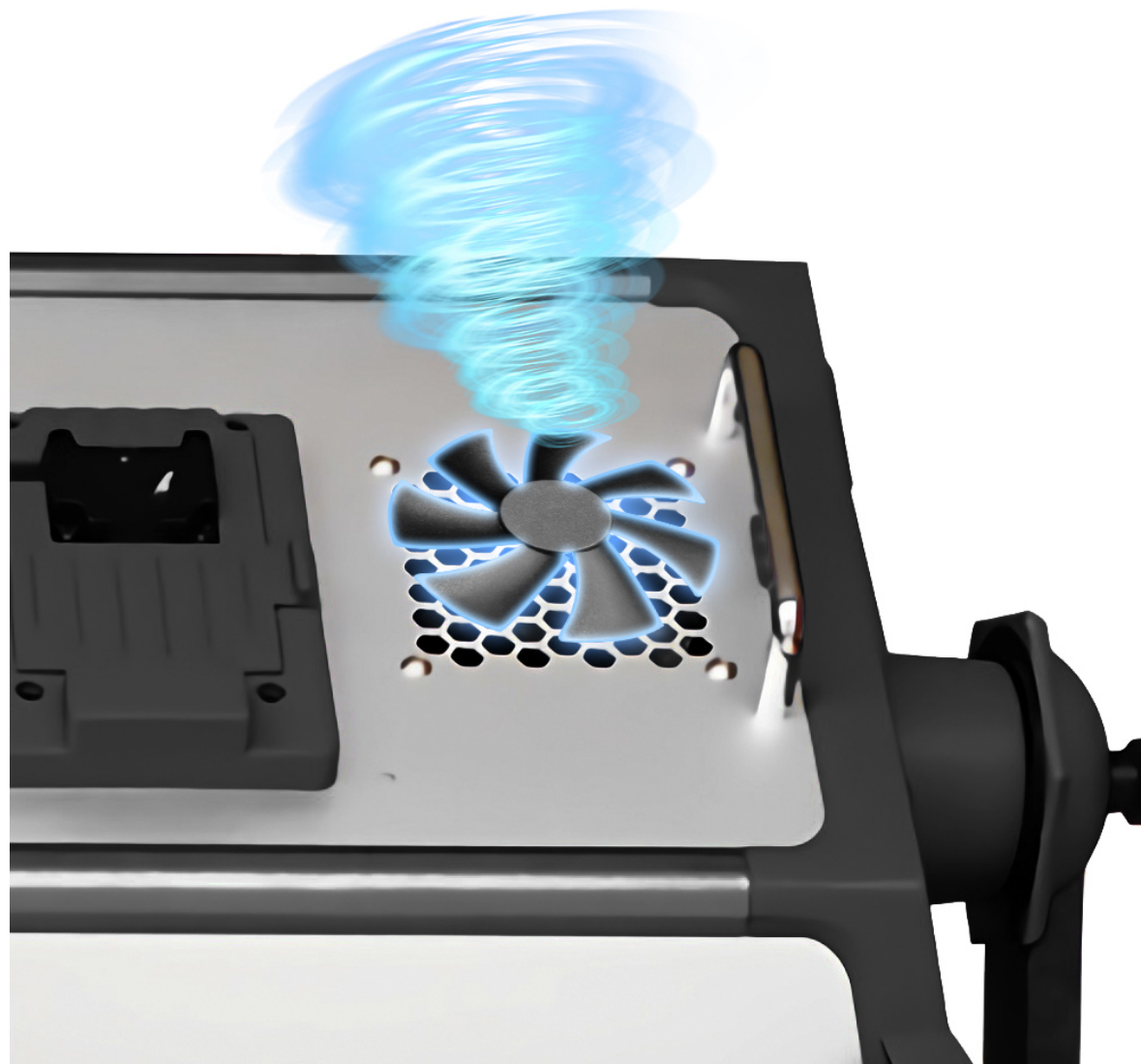

Common color temperature one-key switching 3200K 4400K 5500K

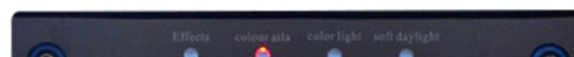

5500K Hot key



3200K Hot key

4400K Hot key

All aluminum alloy ensure quality and heat dissipation

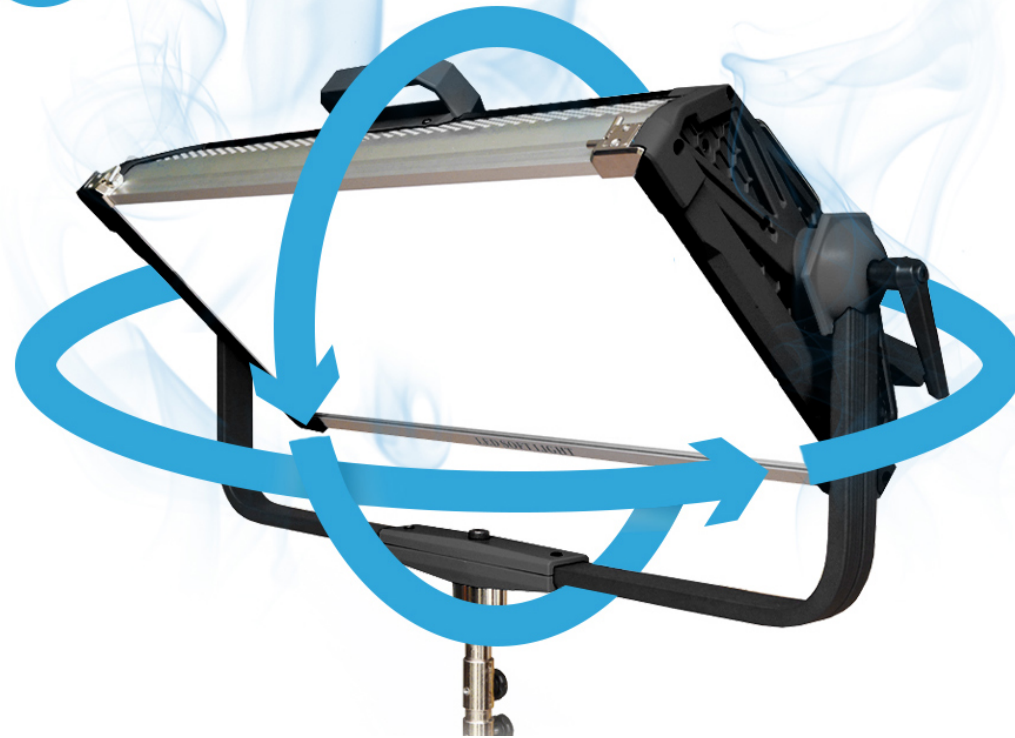

Soft plate is compatible with ARRI S30 Light

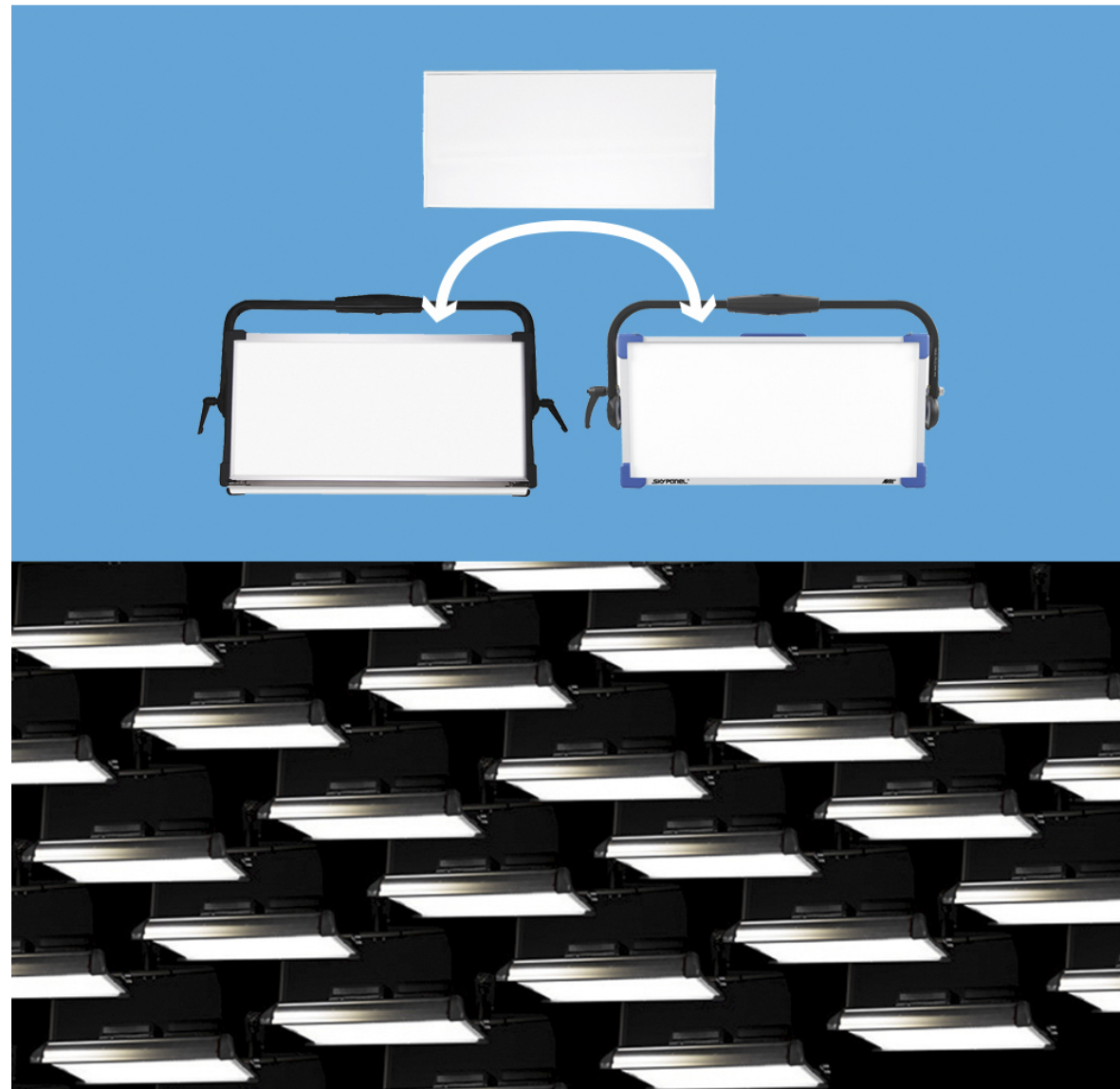





Support DMX control

Support V mount battery&AC 110~220V &DC 26V power light

V mount battery

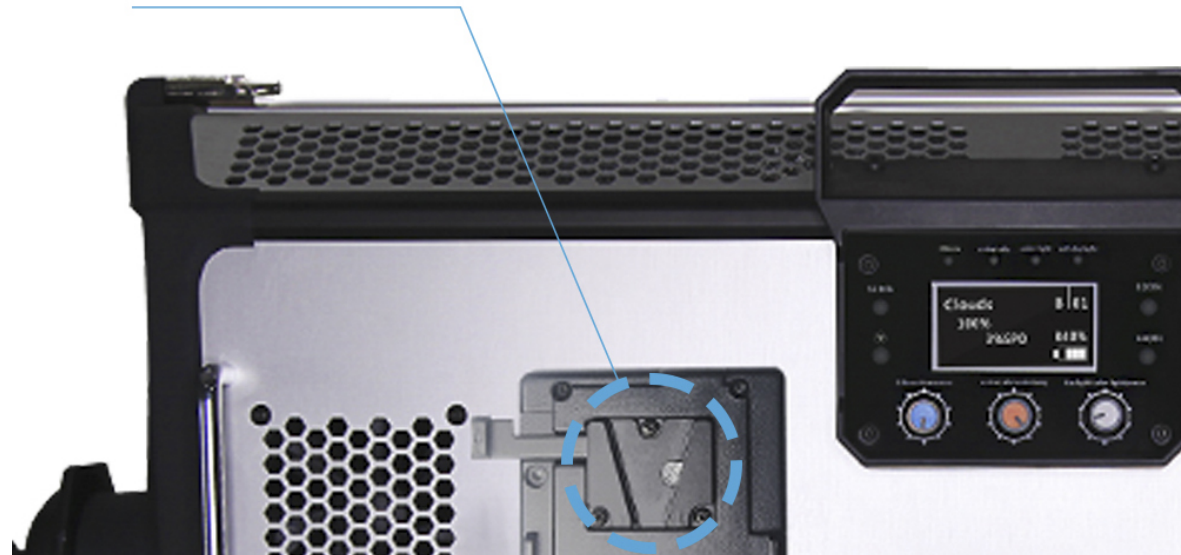



AC 110~220V

DC 26V power light

Download Android APP or APPLE APP on below Barcode



Android APP



APPLE APP

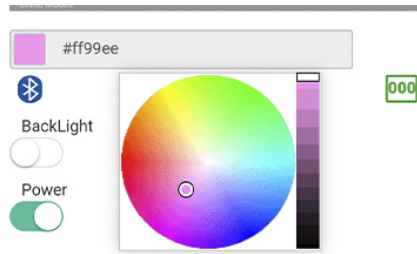

Searching the available Bluetooth of Led equipments.

(click the relevant ID to connect the units)

V2.0.17

ID = B4A

aa11 0000 0201 157c 0000 0564 3205 7b4a 0009 ed

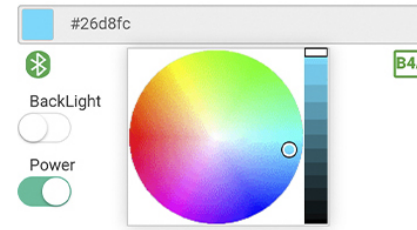

White Color Effects Charts

Brightness + 50

Color Temp + 5500

Hue + 180

Saturation + 50





Focus 9

G N 0

Gradient 5

## COLOR EFFECTS MODE

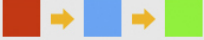
Mode 1	Cop Car	
Mode 2	Club Lights	
Mode 3	Lihtina	

Mode 4	Candle	
Mode 5	Fireworks	
Mode 6	Light Strobe	
Mode 7	Clouds	
Mode 8	Fire	
Mode 9	Color Chase	
Mode 10	Paparazzi	
Mode 11	Pulsing	
Mode 12	Auto-Cycle	

## PACKING LIST

Standard Accessories: S300 Light, AC Cable\*1, Manual, Remote Controller, Soft Light Board, Allen Key, Light Case



Option: 26V V mount 130W Battery, Honeycomb, Softbox



S300 Light



Light Case



Remote Controller



AC Cable\*1



Honeycomb (Option Not Included)



Softbox (Option Not Included)

## USAGE NOTICE

- 1.Read the instructions carefully before use.
- 2.High voltage in light body,non-professionals are strictly forbidden to disassemble light
- 3.Human factors or force majeure is not covered by the warranty.
- 4.Do not use in wet or unventilated environments
- 5.Wipe the light with a soft cloth. Wipe the dirt with a soft cloth and a mild cleaning solution. Do not use a strong cleaner such as thinner, benzine, alcohol, etc in case damaging the surface protection of the light
- 6.Please use 2 pcs 26V battery to power light in case damage light

## REAL USE PICTURES





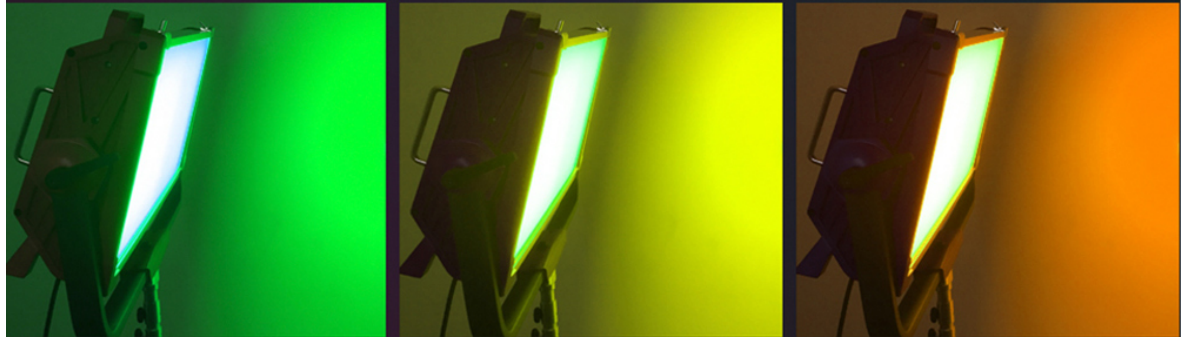
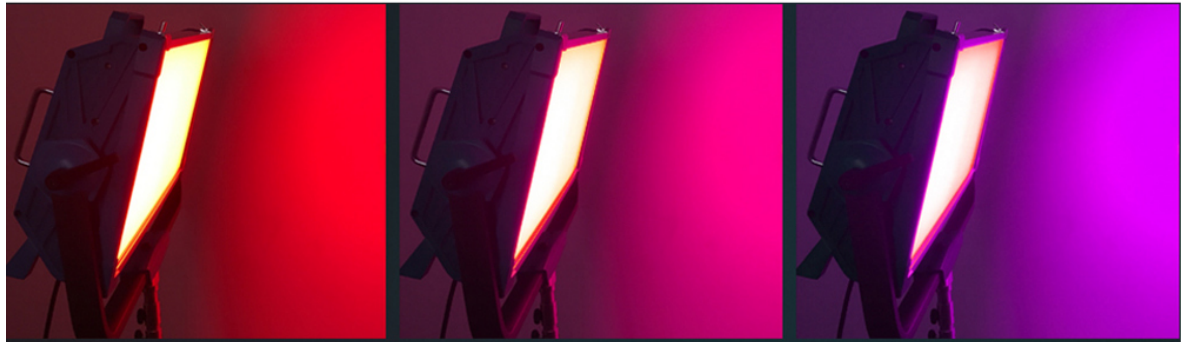

Review

Name

E-mail



Subject

Message

Verification code



Submit

## Newsletter

Subscribe free newsletter to get latest products and discount information.

Send

## Follow us

## Home

## News

Company News

Industry News

## Contact Us



TEL: 008615996404932



E-mail: [admin@digitalfoto.cn](mailto:admin@digitalfoto.cn)



Add: 69# Feitian  
Street, Jiangning  
District, Nanjing, China