

datavideo

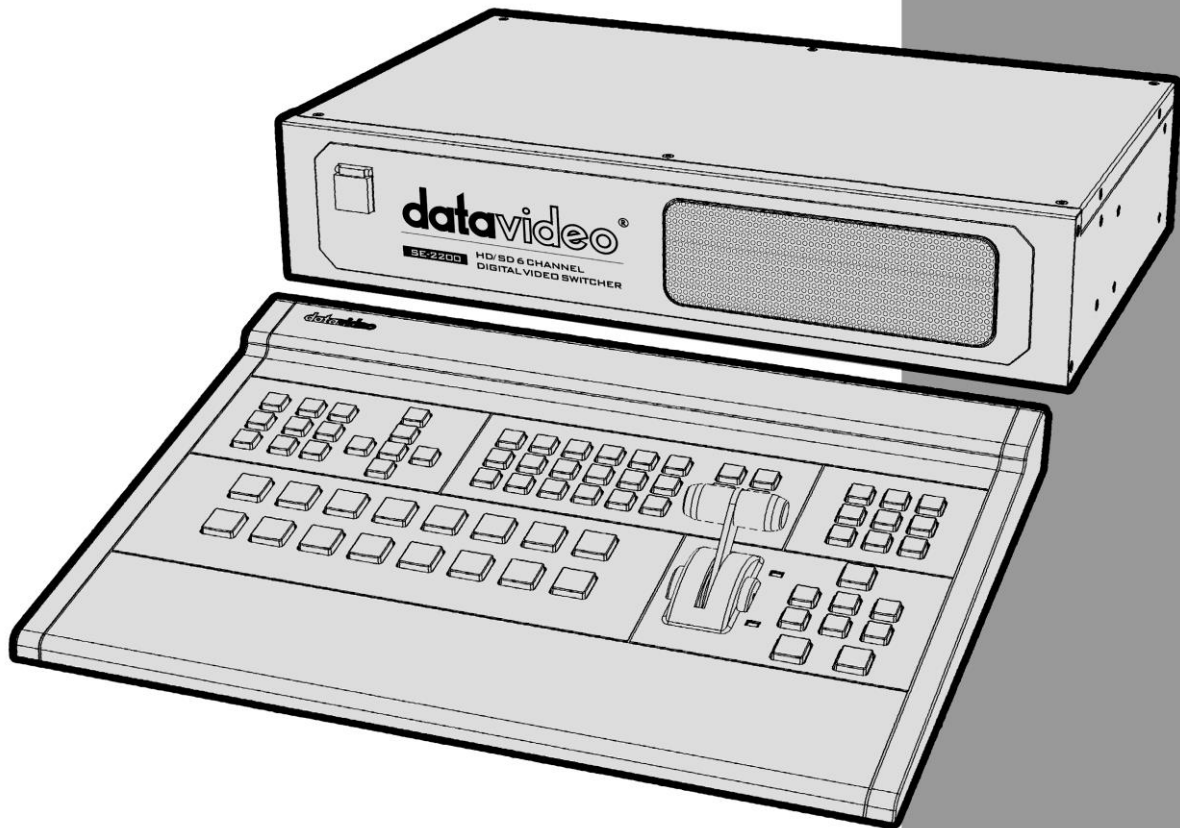

**HD/SD 6 CHANNEL
DIGITAL VIDEO SWITCHER
SE-2200
Quick Start Guide**

www.datavideo.com

Contents

Warranty	3
Disposal	3
Packing List	4
Connection of SE-2200	4
Main Unit – Front Panel	5
Main Unit - Rear Panel	5
Rear Panel Connections	6
Control Panel	8
Keyboard Controls	9
Menu Options	14
How to use the CG-200 software with SE-2200	16
SE-2200 Video Layers	19
Picture in Picture Function	20
PIP Settings	20
PIP Preset and PIP Program	20
Assigning a video source input to a PIP	20
DSK Function	21
AUDIO Function	22
AUDIO FOLLOW VIDEO	23
AUDIO FIXED	23
Audio Menu Options – De-embedding SDI or HDMI audio	24
Working with a fixed or single audio source	25
Switching between different embedded audio sources	25
How to Re-calibrate the SE-2200 T-Bar	26
GPI Connections	27
SE-2200 Tally Outputs	27
Example SE-2200 Set Up	28
Dimensions	29
Specifications	30
Service and Support	32

Warranty

Standard Warranty

- Datavideo equipment is guaranteed against any manufacturing defects for one year from the date of purchase.
- The original purchase invoice or other documentary evidence should be supplied at the time of any request for repair under warranty.
- Damage caused by accident, misuse, unauthorized repairs, sand, grit or water is not covered by this warranty.
- All mail or transportation costs including insurance are at the expense of the owner.
- All other claims of any nature are not covered.
- Cables & batteries are not covered under warranty.
- Warranty only valid within the country or region of purchase.
- Your statutory rights are not affected.

Two Year Warranty

- All Datavideo products purchased after 01-Oct.-2008 qualify for a free one year extension to the standard Warranty, providing the product is registered with Datavideo within 30 days of purchase. For information on how to register please visit www.datavideo.com or contact your local Datavideo office or authorized Distributors
- Certain parts with limited lifetime expectancy such as LCD Panels, DVD Drives, Hard Drives are only covered for the first 10,000 hours, or 1 year (whichever comes first).

Any second year warranty claims must be made to your local Datavideo office or one of its authorized Distributors before the extended warranty expires.

Disposal

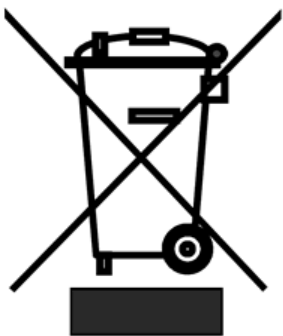

For EU Customers only - WEEE Marking

This symbol on the product indicates that it will not be treated as household waste. It must be handed over to the applicable take back scheme for the recycling of electrical and electronic equipment. For more detailed information about the recycling of this product, please contact your local Datavideo office.

Packing List

1	x	SE-2200 Main Unit
1	x	SE-2200 Control Panel / Keyboard
1	x	SE-2200 Quick Start Guide
1	x	Accessory List

Connection of SE-2200

Use D-SUB Cable to connect SE-2200 main unit to SE-2200 control unit.

SE-2200 Control Unit

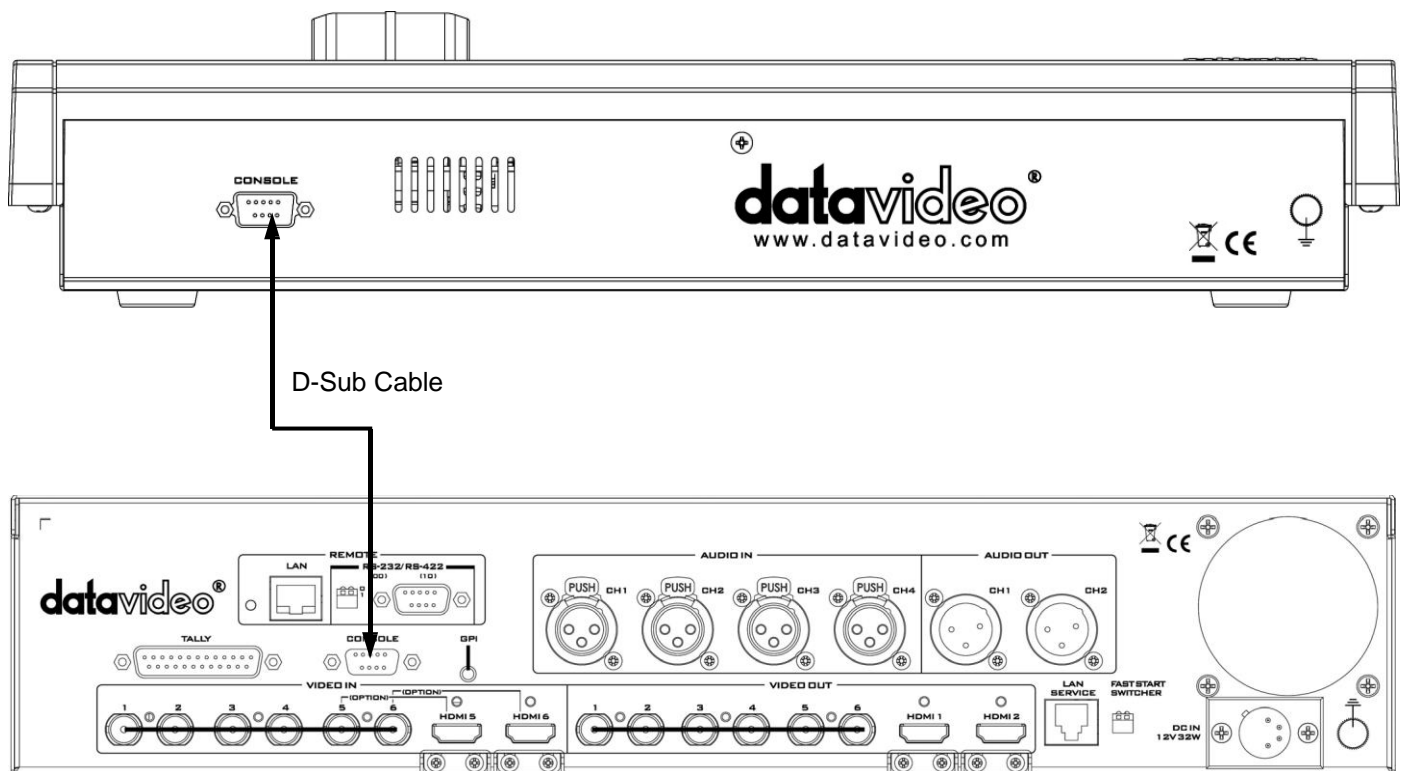

SE-2200 Main Unit

Main Unit – Front Panel



The front panel on the SE-2200 main unit has a grille for airflow cooling fans. Please do not block or cover this grille as the unit may overheat. This grille should also be kept free of dust. The front panel can be removed by using the four thumbscrews. A soft brush or cloth can then be used to clean the grille before attaching it back to the unit.

The power button starts and shuts down both the SE-2200 main unit and its attached keyboard.

Main Unit - Rear Panel

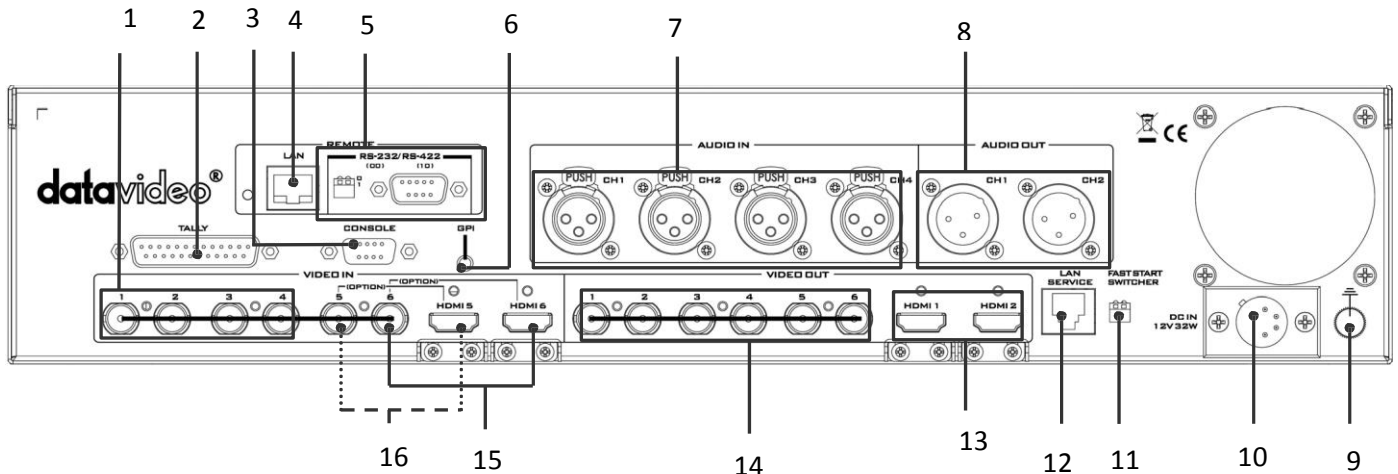

- | | |
|---|--|
| 1. Video Input 1~4 – HD-SDI | 9. Grounding Terminal |
| 2. Tally Output Connector | 10. 4pin XLR Power Input Connector |
| 3. Connect the SE-2200 Keyboard | 11. Mini Switch 2 |
| 4. Ethernet Port for PC Control & Updates (TBD) | 12. Ethernet Port for Load file & Firmware Updates |
| 5. RS-232/422 Connector & Mini Switch 1 (TBD) | 13. Multi View Outputs – HDMI |
| 6. GPI Output Connector | 14. Video Output 1~6 – HD-SDI |
| 7. 3pin XLR Audio Inputs 1~4 | 15. Input 6 – HD-SDI / HDMI (See page 6) |
| 8. 3pin XLR Audio Outputs 1,2 | 16. Input 5 – HD-SDI / HDMI (See page 6) |

Rear Panel Connections

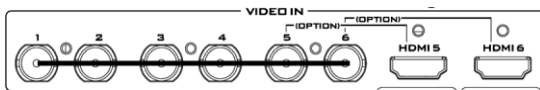

Video Input Modules

The SE-2200 is equipped with six video input channels.

Video Input set is comprised of six SDI connectors and two HDMI ports. The last two channels (#5 and #6) can be switched between SDI connector and HDMI port, i.e. the user is allowed to use CH5 and CH6 for either a SDI source or an HDMI source.

Note: The CG (picture and animation) data source is connected to the SE-2200 channels 5 and 6 via HDMI cable and edit CG function on the PC.

Note: Please enter the SE-2200 MENU to set the input source for **INPUT 5 AND 6**.

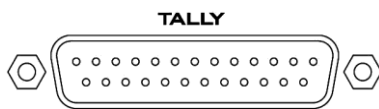

Tally Output

The SE-2200 Tally Output port provides bi-colour tally information to a number of other Datavideo products, such as the ITC-100 eight channel talkback system or the Datavideo TLM range of monitors.

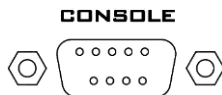

Console Port

This 9pin D-Sub connector is used to connect the Control Panel / Keyboard to the rear of the SE-2200 Main Processing unit.

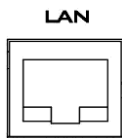

Ethernet Port

For remote control interface (TBD).

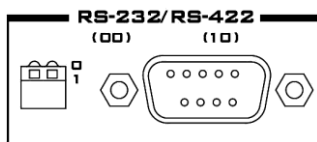

RS-232 / RS-422 Remote

For remote control interface (TBD).



GPI

The GPI socket can be used for simple external control.

Note: Please enter the SE-2200 MENU to select **GPI SETTINGS** to set up GPI function.

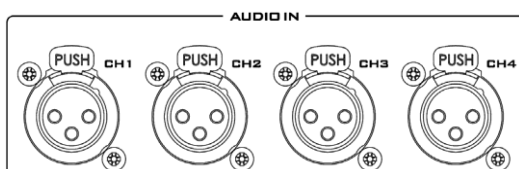

AUDIO Inputs

Supports four channels XLR Balanced Audio Input.

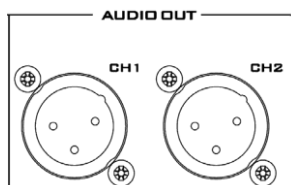

AUDIO Outputs

Supports two channels XLR Balanced Audio output.

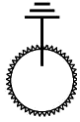

Grounding Terminal

When connecting this unit to any other component, make sure that it is properly grounded by connecting this terminal to an appropriate point. When connecting, use the socket and be sure to use wire with a cross-sectional area of at least 1.0 mm².

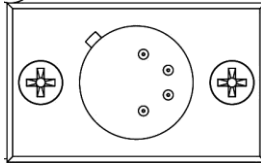

DC Input

Connect the supplied 12V 3A PSU to this 4pin XLR socket.

- Pin 1 = GND (-)
- Pin 2 = NC
- Pin 3 = NC
- Pin 4 = VCC (+)

FAST START SWITCHER



Mini Switch 2

Firmware upgrade switch (The two DIP switches must be set to the UP position).

LAN SERVICE

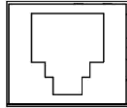

Service Port

This RJ45 Ethernet port is used for updating the SE-2200 firmware, or uploading logo image.

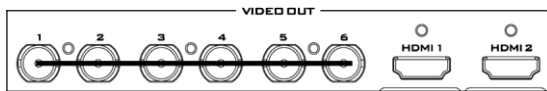

SDI Video Outputs

The six BNC output connectors are user defined SDI outputs. Each of these SDI outputs has the option to be:

1. Program
2. Program logo free
3. Program logo & titles free
4. Preview
5. Aux1,2,3 or 4
6. Multi screen

Note: Please enter the SE-2200 MENU to set the **OUTPUT SOURCE**.

HDMI Multi-View Outputs

SE-2200 is capable of achieving multi-view monitoring by connecting two multi-view monitors to the two HDMI ports. The two HDMI outputs can be used for monitoring video and audio in a number of different configurations.

The HDMI connectors are located on the rear panel.

Note: HDMI multi-view output format is 1080i.

Control Panel

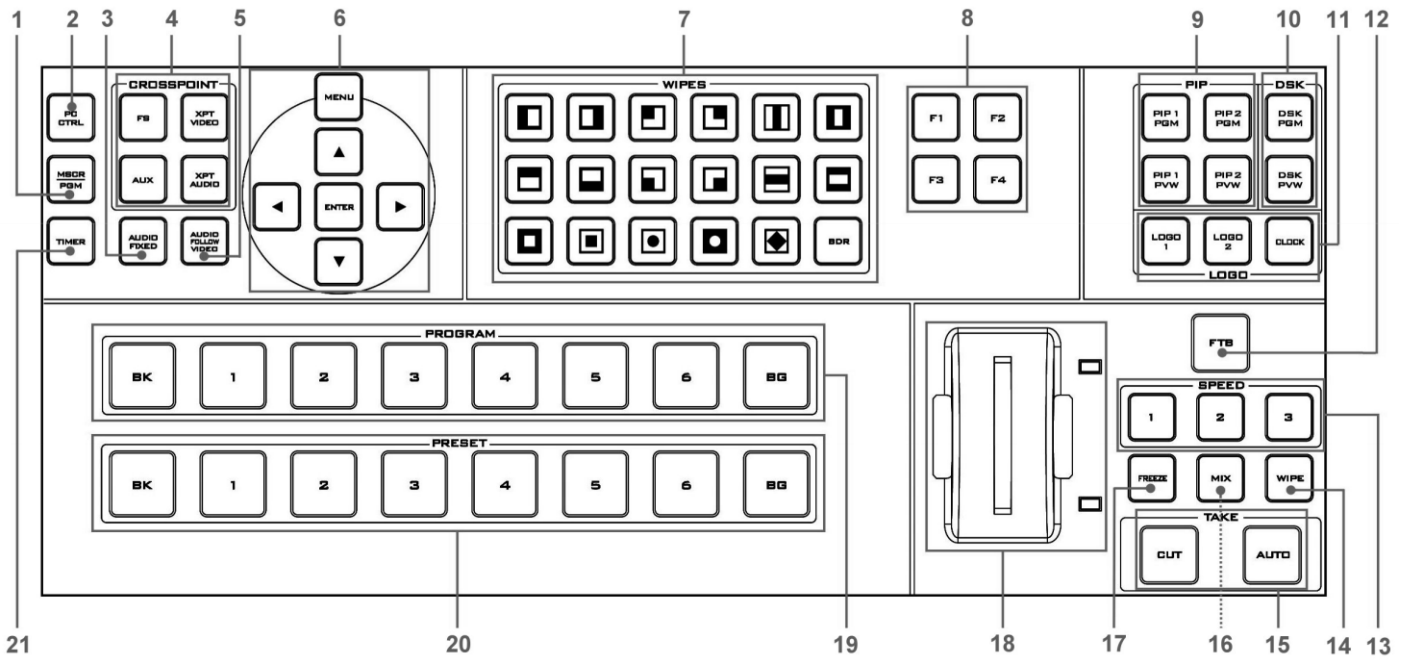

- | | | | |
|-----|-------------------------|-----|---------------------|
| 1. | MSCR PGM | 12. | FTB – Fade To Black |
| 2. | PC Control | 13. | Speed Selection |
| 3. | Audio Fixed | 14. | Wipe Function |
| 4. | Cross Point | 15. | Cut & Auto Take |
| 5. | Audio Follow Video | 16. | Mix Function |
| 6. | Menu Control | 17. | Freezes Function |
| 7. | Transition Selection | 18. | T-Bar |
| 8. | F1~F4 (TBD) | 19. | Program Row |
| 9. | PIP Selection PVW & PGM | 20. | Preset Row |
| 10. | DSK Selection PVW & PGM | 21. | Timer Function |
| 11. | Logos 1, 2, & Clock | | |

Keyboard Controls

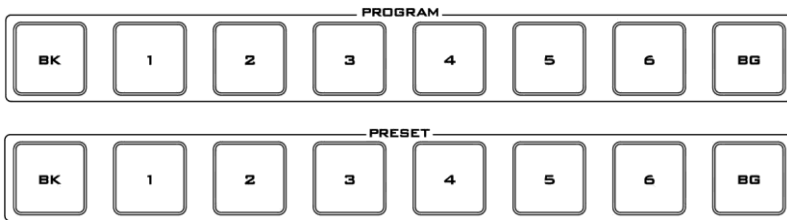

Program and Preset rows

The Program row of buttons is the active channel, this is the live output. The active channel will appear as the Program Output. You can switch or CUT from one video source to another directly on the Program row. You will see the multi view Program output change as you press different keys along this top row of buttons.

The Preset row is the cued channel; this channel will appear in the Preview window. The Preset row selection decides which input will be transitioned next when using any of the transition controls.



BK

Black background – the black background, for use on the Program and Preset row.



BG

Background button – assigns a background colour or colour bars for use on the Program and Preset row.

Note: Please enter the SE-2200 MENU and select **CONSOLE SETTINGS** to set the background colour.



MSCR/PGM

Switch the Multi Screen view or Program view.

Note: This function only works in 1080i mode.



PC Control

Press this key, via computer to control the SE-2200.



Audio Fixed

Manual selection of a mixed of audio channels fixed to a video channel at your choice.

For more detail, please see the **AUDIO FIXED**.

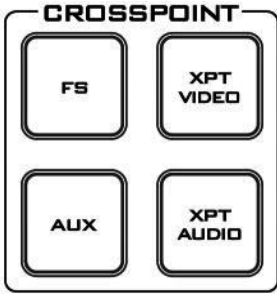

FS – Frame Store Button

The SE-2200 CH1~6 video channels, each of these channels has its own Frame Store. Each of these Frame Stores can hold one still image. This still image can be called into the production by using the FS button located at the top left corner of the SE-2200 Control Panel / Keyboard. The FS button allows the user to toggle between the still image of the Frame Store or the live video input also connected to that same video channel.

How to choose live video input or Frame Store

1. First press and hold down the **FS** button. The Preset row of input sources will light.
2. While still holding down the **FS** button, press the required input on the Preset row.
3. The input button will flash to confirm the Frame Store is selected.

This selection will also be confirmed on the HDMI Multi-view, with the selected channel showing the live input or frame store image.

The contents of each Frame Store are uploaded to the SE-2200 from a PC. The supplied SEConfig software is used to do this.

AUX Source Selection

The SE-2200 has four user defined AUX SDI output, One or all of these outputs can be set up as an auxiliary (AUX) output via a menu option.

The AUX output source can be quickly selected in the following way.

1. First press and hold down the **AUX** button. The Program row of input sources will light.
2. While still holding down the **AUX** button, press the required input on the Program row.
3. The Preset row of input sources will light, .While still holding down the **AUX** button, press the required input on the Preset row.
4. The input button will flash to confirm the AUX source is selected.

XPT Video

Assigning video source, channel setting depended on your selection.

The XPT Video source can be quickly selected in the following way.

1. First press and hold down the **XPT VIDEO** button. The Program row of input sources will light.
2. While still holding down the **XPT VIDEO** button, press the required input on the Program row.
3. The Preset row of input sources will light, .While still holding down the **XPT VIDEO** button, press the required input on the Preset row.
4. The input button will flash to confirm the audio source is selected.

XPT Audio

Assigning audio source, channel setting depended on your selection.

The XPT Audio source can be quickly selected in the following way.

1. First press and hold down the **XPT AUDIO** button. The Program row of input sources will light.
2. While still holding down the **XPT AUDIO** button, press the required input on the Program row.
3. The Preset row of input sources will light, .While still holding down the **XPT AUDIO** button, press the required input on the Preset row.
4. The input button will flash to confirm the audio source is selected.



Audio Follow Video

Manual selection of one audio channel fixed to one video channel at your choice.

When you select video Channe1, the audio source and the video source will be synchronized on Channel 1.

Please see the **AUDIO FOLLOW VIDEO** (Page 23) for more details.

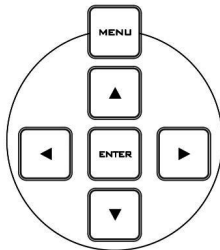

Menu Control

Press the **MENU** button in the SE-2200 function section to enter the System Configuration Menu. Press the **UP**, **DOWN**, **LEFT**, and **RIGHT** arrow buttons to navigate the menu options and to change values. Use the **ENTER** button to save and confirm any setting that has been amended.

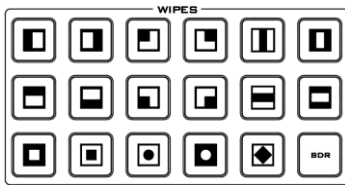

WIPES

The SE-2200 has 17 user defined wipe buttons, and a BDR button.

All wipes can have an optional colour border applied. The wipe border width and colour are chosen within the menu system.

Transitions can be performed manually using the T-Bar or automatically by using the SPEED and AUTO TAKE buttons.



Vertical Wipe Left to Right.



Vertical Wipe Right to Left.



Horizontal Wipe Top to Bottom.



Horizontal Wipe Bottom to Top.



Box Wipe from outside edges to Centre.



Box Wipe from Centre to outside edges.



Upper Left corner Wipe to Lower Right corner



Upper Right corner Wipe to Lower Left corner.



Lower Left corner Wipe to Upper Right corner.



Lower Right corner Wipe to Upper Left corner.



Circle Wipe from Centre to outside edges.



Circle Wipe from outside edges to Centre.



Vertical Wipes from Centre to Left and Right sides.



Vertical Wipes from Left and Right sides to Centre.



Horizontal Wipes from Centre to Top and Bottom.



Horizontal Wipes from Top and Bottom to Centre.



Diamond Wipe from Centre to outside edges.



Border: Enable / Disable wipe border

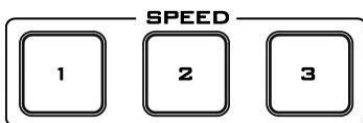

FUNCTION (F1~F4)

TBD

PIP Preview and PIP Program

When looking at the top right corner of the SE-2200 Control Panel / Keyboard there are four PIP keys. These are labelled Program and Preview. The upper PIP1 and PIP2 keys relate to activating Picture In Picture images on the Program outputs. The lower PIP1 and PIP2 keys relate to activating Picture In Picture images on the Multi-view or Preview outputs.

For more detail, please see the **Picture in Picture Function**.

DSK Preview and DSK Program

When looking at the top right corner of the SE-2200 Control Panel / Keyboard there are two DSK keys. These are labelled Program and Preview. The upper DSK key relate to activating Down Stream Keying on the Program outputs. The lower DSK key relate to activating Down Stream Keying on the Multi-view or Preview outputs.

Please see the **DSK Function** (Page 21) for more details.

LOGO 1

The LOGO 1 and LOGO 2 buttons are used to display pre-selected logos on the SE-2200 Preview and Program outputs. When the button is active the selected logo is shown. These logos are selected from the switcher's memory and positioned using a menu option.

LOGO 2 or CLOCK

The user cannot display LOGO 2 and CLOCK at the same time. Instead use LOGO 1 and CLOCK together or use LOGO 1 and LOGO 2 together.

FTB

Fade To Black, this button fades the current video program source to black. When pressed again it acts in reverse from complete black to the currently selected program video source.

SPEED

There are three speed buttons which can be defined by the user. By pressing a speed button the user is choosing the rate of transition or time taken when using the AUTO TAKE button.

Note: Please enter the SE-2200 MENU and select **CONSOLE SETTINGS** to set up **SPEED BUTTON**.

WIPE

The WIPE button is selected when a wipe effect transition between the selected Program and Preset sources is required. This WIPE effect is produced by then moving the T-Bar manually or by pressing the AUTO TRANS button.

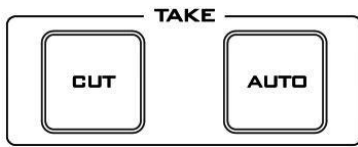

CUT

This performs a simple immediate switch from the current main source to the selected sub source. The selected transition wipe or MIX is not used.

AUTO TAKE

This performs an automated switch from the current program source to the selected Preview source. The selected transition wipe or MIX will also be used. The timing of the transition is set by the chosen Speed button.



MIX

Pressing this button selects a basic A/B Dissolve for the next transition.



FREEZE

Freeze the program source image or return to live video of the selected program source.

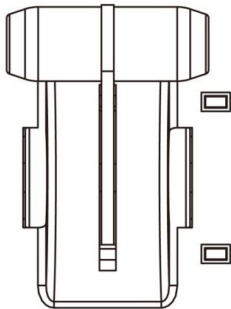

T-Bar

This performs a manually controlled transition from the current program source to the selected Preset source. The selected transition wipe or dissolve will be used. When the T-Bar has travelled as far as it can go the transition between sources is complete. The T-Bar has indicators next to it which light when the transition is complete.

The T-Bar can be operated in one of two modes which are chosen by a menu option.



TIMER

In some mixing or switching applications it is useful to have a countdown timer. It could be that the input is a pre-recorded video clip and you need to know when to be ready to switch away from it.

This countdown timer function is only seen in the status area of the HDMI multi-view output to the right of the normal Clock function. The timer can be selected for one input channel, several channels or all channels.

When the TIMER button is active and the user switches to a selected input channel the countdown starts on the HDMI multi-view.

The value of the countdown, in minutes and seconds (MM:SS).

When the countdown reaches zero the user can then switch or transition to another input channel. If the countdown reaches zero the switcher will not automatically change to the selected Preset source.

Set up the Countdown Settings

1. Select one channel of **PRESET CH1~6**
2. Press **MENU** key to enter **ON PREVIEW SETTING** to set up the **COUNT DOWN SETTING**.
3. Press **ENTER** key to save your setting, and then exit the **MENU** Mode.
4. Press **TIMER** key, and then select one channel of **PROGRAM CH1~6** (same as step 1 channel setting).

Menu Options

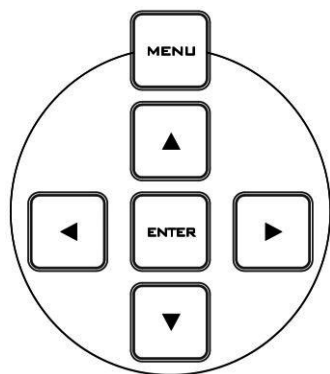

When the **ENTER** button is pressed the Main Menu list is displayed on the HDMI 1 Multi-view output.

This section covers the Menu options in the order that they appear on the SE-2200 HDMI 1 Multi-view. These settings may also appear in more detail elsewhere in this instruction manual. Options may vary depending on the firmware version in use.

Once the chosen setting has been confirmed with the **ENTER** button it is stored within the switchers non-volatile memory.

** This table is under HD 1080i mode values.*

Version No	Where xx.xx is the firmware version number		
1. Mode	1080i 720p SD 4:3 SD 16:9	The Video can be changed to the desired standard.	
2. On Preview Settings	Video Settings	Brightness Range 072 to 184	
		Contrast Range 36 to 92	
		Saturation Range 36 to 92	
		Aperture 0~3	
		Y-C Delay 0~3	
		Set to Nominal Reset to default values	
Audio Settings	Count Down Settings	Level	
		Set To Nominal	
		Down Counter is on	
		Count Down Value	
3. Input 5 and 6 Mode	Input 5 Input 6	SDI	
		HDMI	
		HDMI Color Mode	RGB
			YUU_422
		YUV_444	
4. Outputs Sources	Output 1~6	OUT 1~6 is user choice of : Program Program Logo Free Program Logo & DSK Free Preview Aux 1~4 Multi Screen	
5. Aux Selection	AUX 1~4	1~6	

Note: Each input can be selected for **Count Down** ON or OFF. If **Count Down** is ON then the **Down Counter** value is set in minutes and seconds (MM:SS), Max = 1 Hour or 60:00, and Default = 15 seconds or 00:15

6. Audio Settings	Dynamic Range (dB)	18 or 24	
	Audio Cross Point	Button 1~6	1~6
	SDI De-EMB. Audio Setup	Input 1~6	Group 1~4 Pair 1, 2
	HDMI De-EMB. Audio Setup	Input 5, 6	1~4
	Audio (Re)-Embedding Setup	Output 1~6	1~4
	Audio Mixing Type	X-Type, V-Type X-Type = A/B Cross Fade V-Type = Fade Out A then Fade In B	
7. PIP Settings	PIP1 PIP2	Horizontal Position	000~107
		Vertical Position	000~108
		Window Size	01~33
		Border Width	00~05
		Border Color	01~08
8. LOGO Settings	Logo 1 Logo 2	Logo Selection	001~008
		Horizontal Position	000~110
		Vertical Position	000~124
9. Clock Settings	Horizontal Position	000~110	
	Vertical Position	000~124	
	Set Hours	0~24	
	Set Minutes	0~59	
	Clear Seconds		
10. DSK Settings	DSK	On / Off	
	Luma Key Mode	On / Off	
	Luma Key Level	Luma Key Level 0 (black) to 255 (white)	
11. Wipe Border Settings	Wipe 1~17	Width	0~4
		Color	1~8
12. Multi Screen Setting	Multi Screen Mode	Variant A/B/C	
	Multi Screen Audio Setup	Preview/Program	
	Multi Screen Audio Indicator	ON/OFF	
13. Console Settings	T-Bar Audio Mixing Type	Follow T-Bar / By the END	
	T-Bar Mode	One Way Mode / Two Way Mode	
	Speed Button Setting	Speed 1/2/3	4~64
	B-Ground: 1~8=Color; 9 = Bars	1~9	
	Button Settings	Brightness	000~004
Backlight is ON		On / Off	
	1 kHz to Bars is On	On / Off	
14. GPI Settings	Input Select	0~6 GPI Select by CH1~6 (0 = GPI function disable)	
	Time Delay	01~75 Delay time can be set at 01~75 frame	
15. Remote Control	Ethernet		
	DVIP board		
16. Factory Settings	Tick selections enable = Reset all settings to their default values		

How to use the CG-200 software with SE-2200

For example:

1. Use HDMI cable to connect the PC to the SE-2200 (CH-6).

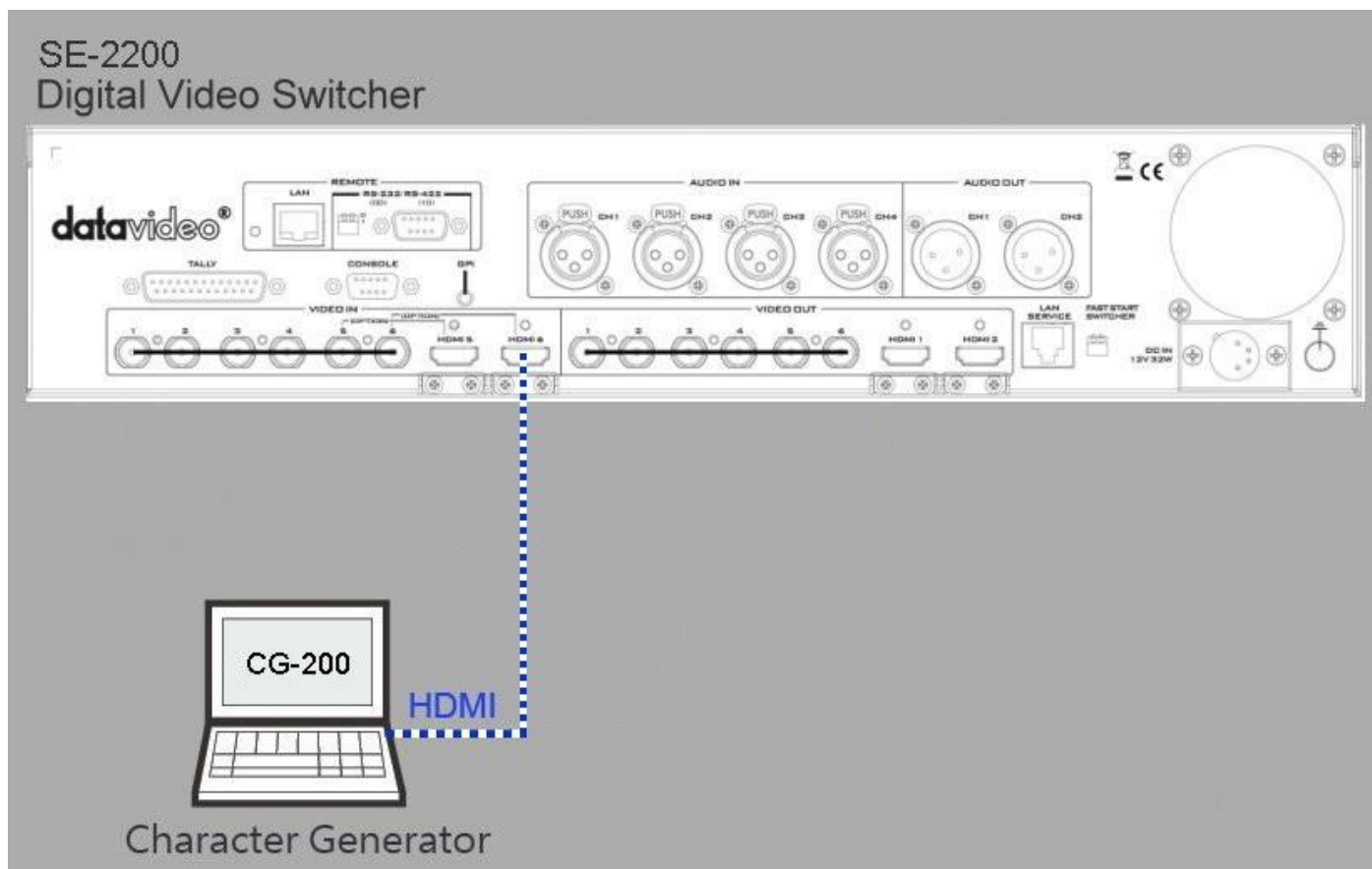

2. Enter SE-2200 Main Menu to set Video Standard.

1. Mode	1080i 720p SD 4:3 SD 16:9	The Video can be changed to the desired standard.
---------	------------------------------------	---

3. Enter SE-2200 Main Menu to set Video Input 6 on HDMI.

3. Input 5 and 6 Mode	Input 5 Input 6	SDI	
		HDMI	
		HDMI Color Mode	RGB
			YUV_422
		YUV_444	

4. Activate DownStream Key on SE-2200 Control Keyboard. Please see the DSK Function (Page 21) for more details.

5. Install the CG-200 software to the PC.



Step1: Please click the icon to install CG-200 Software

Step2: Install the CG software step by step till it's finished.



Step3: When finished, please double click the CG-200 icon to execute the software.

6. Click **Settings** → **Preferences** to select Video Mode (the video mode must be the same as SE-2200).

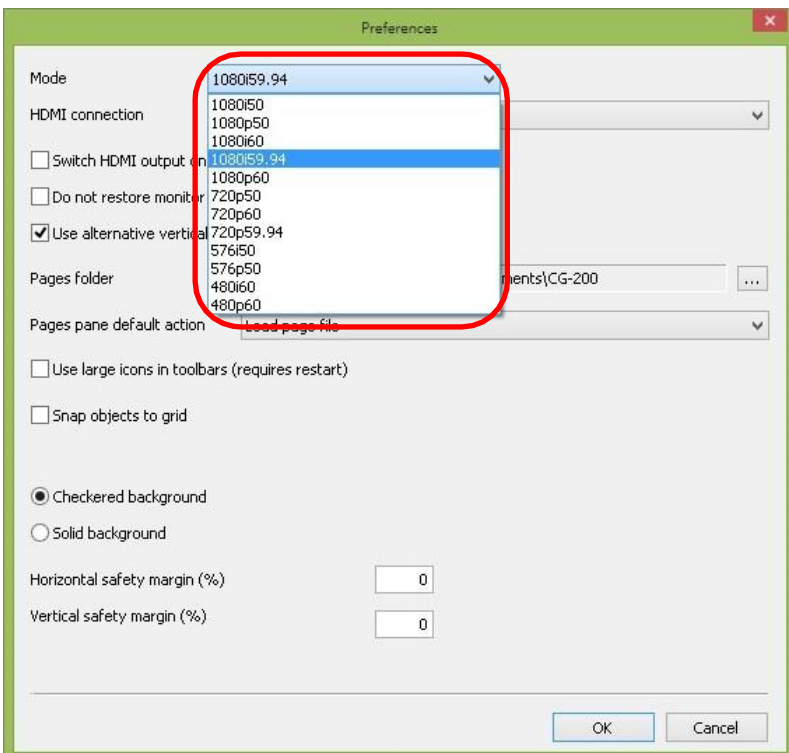
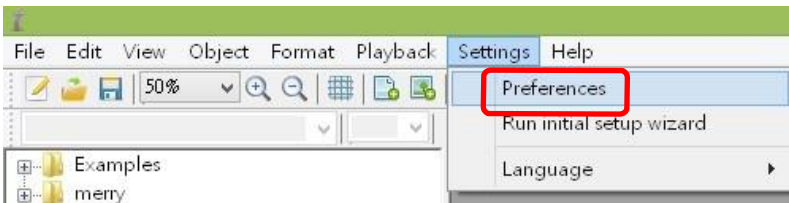

7. Select DEMO file to play the CG data (the video standard must the same as SE-2200).

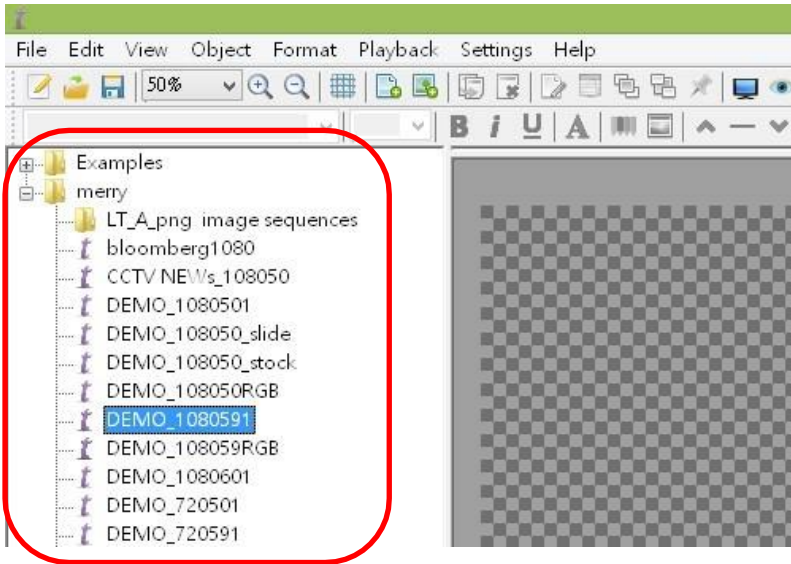

8. Set HDMI output to "ON".

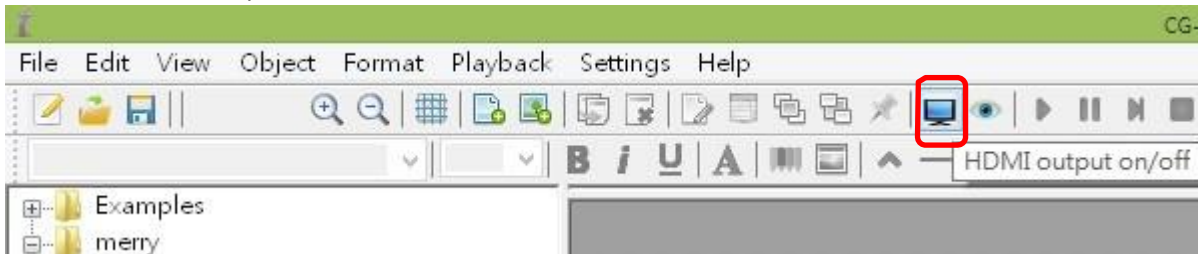

9. Enter "Play all" to enable CG function.

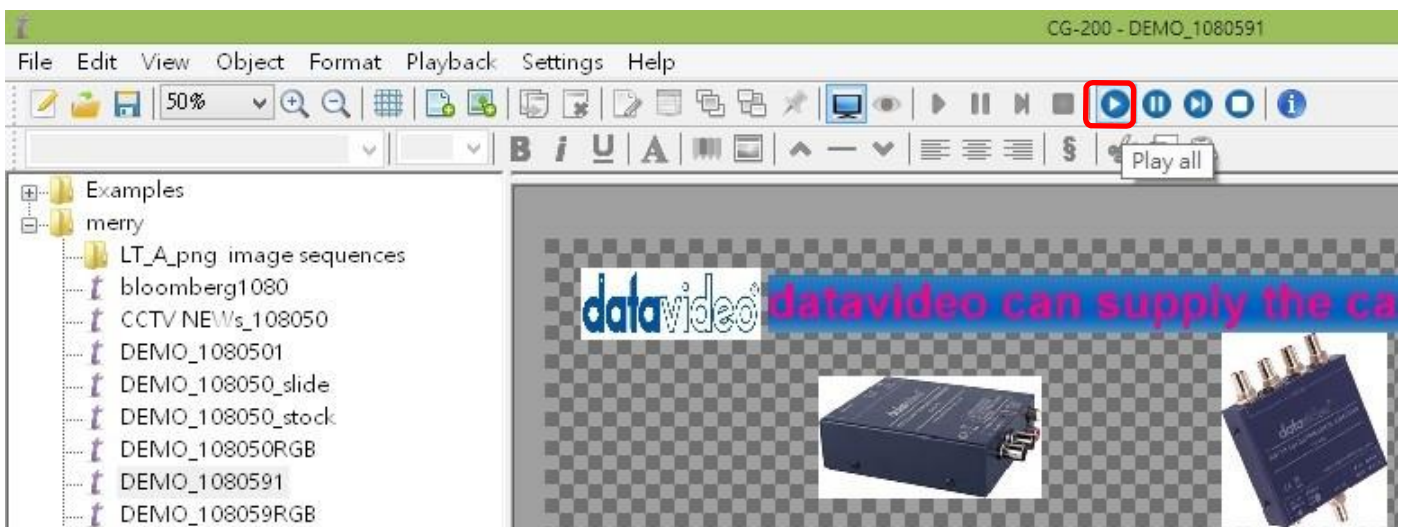

SE-2200 Video Layers

The SE-2200 is a Standard Definition or High Definition Digital Video Switcher and as well as mixing video and audio sources it has additional functions such as Picture in Picture (PIP), DSK LUMA KEY and LOGOs.

Before attempting to use the SE-2200's PIP, DSK LUMA KEY and LOGO functions it may help to first understand the order of the video layers at the SE-2200 Program (PGM) outputs.

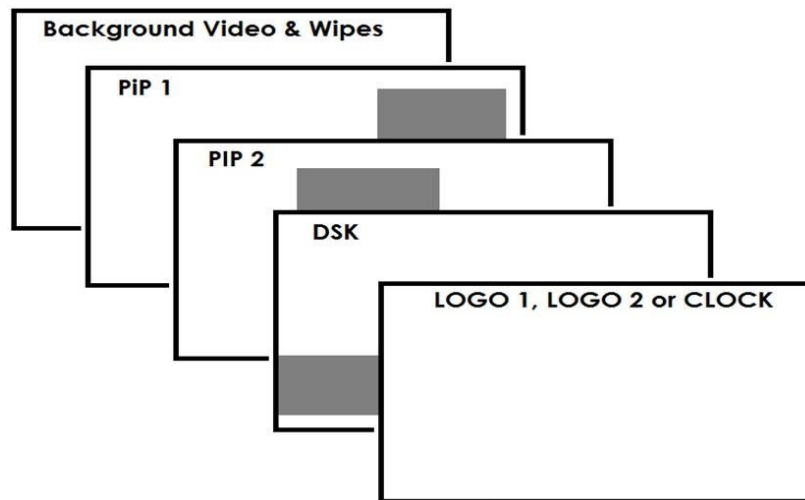

The **Background video layer** is the normal video layer when mixing and switching with the SE-2200. It occupies the whole screen area of the Program output. This layer can be hidden or part hidden by the PIP, DSK and LOGO layers in front of it.

The **PIP 1 layer** does not occupy the whole screen and is shown in front of the Background video layer when enabled. In some setups the PIP 1 image can be hidden behind the PIP 2 image. This is not a fault. Change the position or size of the PIP 1 or PIP 2 image if required.

The **PIP 2 layer** does not occupy the whole screen and is shown in front of the Background video and PIP 1 layers when enabled. In some setups the PIP 1 image can hide the PIP 2 image. Change the position or size of the PIP 2 or PIP 1 image if required.

The **DSK layer** can occupy the whole screen. If set up incorrectly this layer can stop the video layers behind it from being seen properly. Re-adjust your DSK 1 settings or switch off the DSK1 function on the SE-2200 to restore the video behind it.

The **LOGO and Clock layer** does not occupy the whole screen and all other layers are visible through it. A logo if positioned incorrectly can partially hide an important part of the video, PIP or CG LUMA KEY layers. Typically logos or station ID bugs are placed in a corner of the screen.

Note: Where possible prepare and position the upper video layer elements in advance of the live production starting to avoid them appearing on the program output incorrectly.

Most broadcast networks have guidelines and advice on the use of video, images, music, logos and on screen text so it is best to check beforehand when planning a production. Do not use copyright protected content until you have the relevant permissions. Information on royalty free video, images and music is widely available, speak to your local dealer or search for advice on the internet.

Picture in Picture Function

The SE-2200 Picture in Picture function allows you to place one or two smaller PIP images over a chosen full size background image. The smaller PIP images can be set to pre-defined sizes and positioned almost anywhere within the Preset/Program screen area. These PIP windows can also have a coloured border applied, and can be brought into the production with a default PIP dissolve transition.

PIP Settings

Before trying to activate the PIP function it is best to understand how to set up or choose the right options for your production. Press the **ENTER Key** in the **MENU** area of the SE-2200 keyboard. Navigate to the **PIP Settings** option using the down arrow key. The PIP menu options provided here are:

PIP Settings	PIP1	Horizontal Position	= 000 to 107 (Left to right)
	PIP2	Vertical Position	= 000 to 108 (Lower to Upper)
		Window Size	= 1 (small) to 33 (large)
		Border Width	= 0 (OFF), 1 (Thin) to 5 (Thick)
		Border Color	1 = White, 2 = Yellow, 3 = Light Blue, 4 = Green, 5 = Purple, 6 = Red, 7 = Dark Blue, 8 = Black.

PIP Preset and PIP Program

When looking at the top right corner of the SE-2200 Control Panel / Keyboard there are four PIP keys. These are labelled Program and Preset.

The upper PIP1 and PIP2 keys relate to activating Picture In Picture images on the Program outputs.

The lower PIP1 and PIP2 keys relate to activating Picture In Picture images on the Multi-view or Preview outputs.

Assigning a video source input to a PIP

Using the lower PIP1 or PIP2 buttons you can assign a selected video input to the chosen PIP video layer.

1. First press and hold down the required PIP button on the lower row. The Preset row of input sources will light.
2. While still holding down the PIP button, press to select the required input from the Preset row.
3. The input will flash to confirm it is selected.

This selection will also be confirmed on the HDMI Multi-view, with a P1 or P2 label shown next to the selected input image.

DSK Function

The SE-2200 has two Down Stream Keys (**DSK PGM**, **DSK PVW**). This means it is able to take a key source video input and replace the white or black parts of this image with the video from another source. If the input video carries an alpha channel it is also possible to key in this way too.

DSK Settings

Before trying to activate the DSK function it is best to understand how to set up or choose the right options for your production well in advance of the production.

Press the **ENTER Key** in the **MENU** area of the SE-2200 keyboard. Navigate to the **DSK Settings** option using the down arrow key. The DSK menu options provided here are:

DSK Settings	DSK Luma Key Mode Luma Key Level	Luma Key Level 0 (black) to 255 (white)
---------------------	---	--

DSK PVW and DSK PGM

When looking at the top right corner of the SE-2200 Control Panel / Keyboard there are two DSK keys. These are labelled Program and Preset.

The upper DSK PGM key relates to activating Down Stream Keying on the Program outputs.

The lower DSK PVW key relates to activating Down Stream Keying on the Multi-view or Preview outputs.

Assigning an input to a DSK PVW channel for keying

Using the lower DSK PVW button you can assign a selected video input to the chosen DSK video layer.

1. First press and hold down the DSK PVW button on the lower row. The Preset row of input sources will light.
2. While still holding down the DSK PVW button, press to select the required input from the Preset row.
3. The input will flash to confirm it is selected.

This selection will also be confirmed on the HDMI Multi-view, with a T1 label shown next to the selected input image.

AUDIO Function

Overview

The SE-2200 has a simple, cost effective, audio switcher built in. The SE-2200 has the ability to take audio from several sources either XLR analogue, SDI and/or HDMI inputs. The audio can be embedded onto the HDMI and SDI outputs and/or fed to the analogue XLR audio connections.

When using the audio functions of the SE-2200 switcher you may de-embed audio from selected SDI or HDMI inputs and then output this audio from the XLR outputs of the switcher to a separate audio mixer like the Datavideo AM-100 audio mixer.

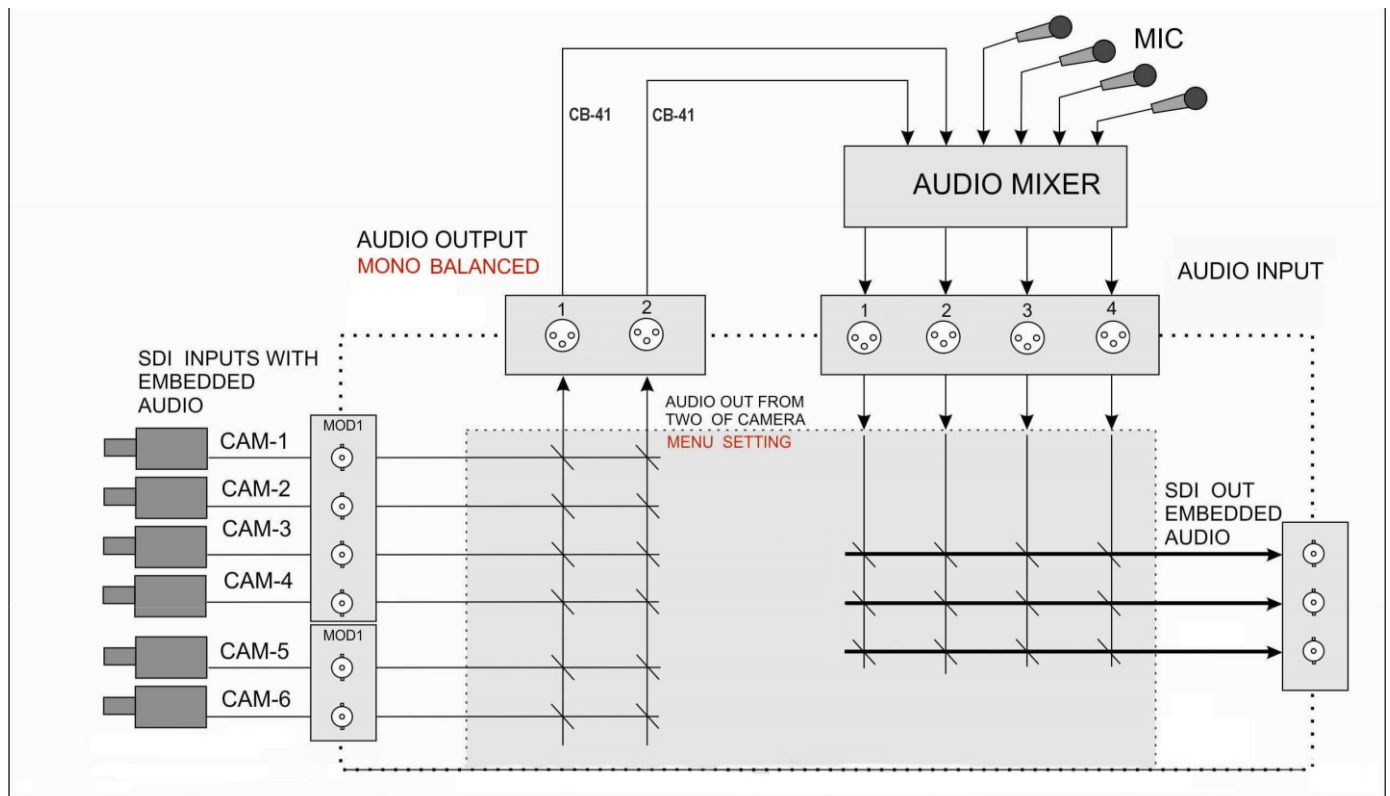

Once the audio is mixed externally with any microphones or audio sources it can then be fed back into the SE-2200 on the analogue XLR inputs. The SE-2200 can then embed this externally mixed audio on to the Program SDI outputs.

AUDIO FOLLOW VIDEO



AUDIO FOLLOW VIDEO function is also known as audio follow video. This means that the audio source will switch with the corresponding video input, and actually follow the T-bar function. The active audio is de-embedded and sent to the audio output terminals for processing and/or audio levelling/ and or adding more audio sources. The resulting audio will return and be connected to the audio inputs for the purpose of (re)-embedding the audio to the SDI output. The selection of the audio groups determines the SDI channel that the audio will be embedded to exactly.

AUDIO FOLLOW VIDEO function is primarily used in talk show or live news broadcasting. Voices of different guests are directly collected by the corresponding cameras, thus, when the program director switches between different guests, the video is switched at the same time with voice of the guest during program broadcasting. This function is definitely an indispensable function during live broadcasting.

AUDIO FIXED



The **AUDIO FIXED** method, allows a user to manually select which audio input can be matched to the SDI video input and assigned to the audio output terminals, which is shown in the example below:

The table below illustrates that the sound of video input 1 is used for all individual video inputs.

	SE-2200 Audio INPUT Channel	SE-2200 Assigned Audio Output Channel
AUDIO ASSOCIATIONS	INPUT 1 (BUTTON 1)	1
	INPUT 2 (BUTTON 2)	1
	INPUT 3 (BUTTON 3)	1
	INPUT 4 (BUTTON 4)	1
	INPUT 5 (BUTTON 5)	1
	INPUT 6 (BUTTON 6)	1

The **AUDIO FIXED** function is primarily used during big (concert) events and (wedding) parties. One camera picks up the audio of the audience and/or ambience of that video input 1, which is assigned to be sent to the audio output. The other cameras are assigned to this same audio of video input 1. When the operator switches between the video sources, the sound of video input 1 remains on all the time.

Audio Menu Options – De-embedding SDI or HDMI audio

Using the following SE-2200 menu options audio can be selected from the SDI or HDMI video inputs.

SDI De-EMB. Audio Setup	Inputs 1 to 6	User choice of	Group 1,2,3 or 4 Pair 1 or 2
HDMI De-EMB. Audio Setup	Input 5 or 6	User choice of	Pair 1,2,3 or 4

As each SDI / HD-SDI source can have up to sixteen channels of audio, and HDMI eight channels, we need to choose the audio channels with the options above and by the following reference tables.

SDI Inputs Embedded Audio		
Group	Stereo Pair	Channel
Group 1	Stereo pair 1	1
		2
	Stereo pair 2	3
		4
Group 2	Stereo pair 3	5
		6
	Stereo pair 4	7
		8
Group 3	Stereo pair 5	9
		10
	Stereo pair 6	11
		12
Group 4	Stereo pair 7	13
		14
	Stereo pair 8	15
		16

HDMI Inputs Embedded Audio	
Stereo Pair	Channel
Stereo pair 1	1
	2
Stereo pair 2	3
	4
Stereo pair 3	5
	6
Stereo pair 4	7
	8

In some cases there may only be two channels of audio associated with the video: Stereo Pair 1.

Working with a fixed or single audio source

Example 1:

We have two mono mics (channels 1 & 2) connected to an HD camera. These embedded audio channels are then output from this camera, HD-SDI, to the SE-2200 switcher. If we want to only hear these two audio channels regardless of the video channel used then we would set up the switcher in the following way.

Press the ENTER key in the MENU area of the SE-2200 keyboard to display the on screen menu on the **AUDIO ASSOCIATION of AUDIO SETTING**.

Change the Audio Association settings in the menu system to show a value of 1 for each video input channel. Press the ENTER key to store the audio values chosen for each video input.

Change the SDI Embedded Audio setting in the switcher's menu system to show a value of Group 1 and Pair 1. Press the ENTER key to store the audio values chosen for each video input.

Now exit the menu by pressing any wipe key and look at the **AUDIO FIXED** button in the wipes area of the keyboard.

Select the **AUDIO FIXED** status with this button when looking at the status area of the HDMI multi-view. The button will be backlit red.

Switching between different embedded audio sources

Example 2:

We have two mono mics each connected to a different HD camera. The embedded audio is then output from each camera, HD-SDI, to the SE-2200 switcher. If we want to hear the audio from each camera as the video channels are switched, **audio follows video**, and then we would set up in the following way.

Press the ENTER key in the MENU area of the SE-2200 keyboard to display the on screen menu on the **AUDIO ASSOCIATION of AUDIO SETTING**.

Change the **Audio Association** settings in the menu system to show a value of 1 for each video input channel that is associated with audio input 1. Then change to a value of 2 each video input channel that is associated with audio input 2. Press the **ENTER** key to store the audio values chosen for each video input.

Change the **SDI Embedded Audio** setting in the switcher's menu system to show a value of Group 1 and Pair 1. Press the **ENTER** key to store the audio values chosen for each video input.

Now exit the menu by pressing any wipe key and look at the **AUDIO FIXED** button in the wipes area of the keyboard.

Select the **AUDIO FOLLOW VIDEO** status with this button when looking at the status area of the HDMI multi-view. The button will be off. The status area is located just below or near the Preset image on the HDMI multi-view monitor.

When switching between the video sources the audio sources will also change. We can choose how the audio will change sources, whether it is a clean cut (immediate switch) or some sort of transitioned change (cross fade or fade out & in). To do this we would need to set up with the following menu options.

Auto Audio Mixing Type	User choice of	X type or V type Tick selection	X type = A/B cross fade V type = Fade out A then fade in B
T-Bar Audio Mixing Type	Tick selection of	Follow auto audio mixing type (use above option) By the end (clean cut or immediate audio switch)	

How to Re-calibrate the SE-2200 T-Bar

After a firmware update of the switcher it will be necessary to re-calibrate the T-Bar to get it working correctly.

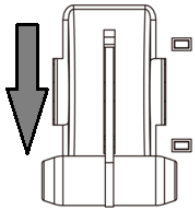

1. Move the **T-Bar** to its **lowest position**.

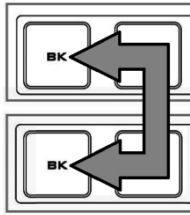

2. **Power OFF** the SE-2200 switcher.
3. **Press and hold down BK** button on both the Program and Preset rows of the switcher's keyboard.

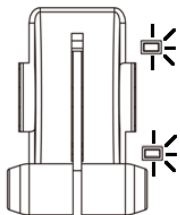

4. **Power ON** the SE-2200 switcher while **still holding down the buttons** in step 3.
5. The switcher will start but the keyboard lights will remain dead except for the T-Bar progress LEDs. When these **LEDs flash ON and OFF** release the buttons from step 3.

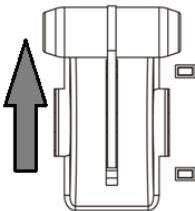

6. Move the **T-Bar to its top position** and then press the **CUT button**.

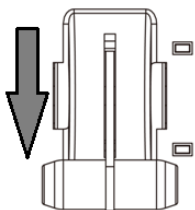

7. Move the **T-Bar back to its lowest position** and then press the **AUTO TAKE** button.



8. To exit the calibration procedure, press the **CLOCK button**.

9. Ensure the **TIMER button** is **OFF**.

10. Test the T-Bar.
If necessary change the **T-Bar Mode** in the **OSD MENU options**.

GPI Connections

The SE-2200 can control external recorder/playback devices like the HDR-60/70 via simple contact closure GPI switch.

The GPI interface is a 3.5mm Jack Socket which is situated on the rear panel of the SE-2200. Contact closure between the Outer and Inner contacts on the jack plug will trigger a user selected event. Power is supplied by the SE-2200 and is less than 5V DC.

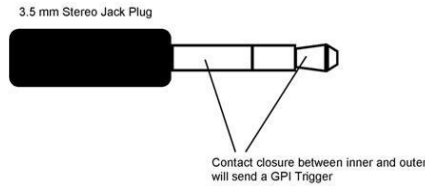

This GPI socket can also be used as a socket to trigger record or playback events with other equipment such as the Datavideo HDR-70 recorder.

SAFETY FIRST The cabling required needs to be designed specifically to connect the SE-2200 to the chosen record or playback device as they are not all the same. The cabling required can be made by yourself or a competent technician. Please speak with your Dealer or local Datavideo office to get further help and advice.

SE-2200 Tally Outputs

The SE-2200 has a D-sub 25 pin female tally output port. These connections provide bi-colour tally information to a number of other Datavideo products, such as the ITC-100 eight channel talkback system and the TLM range of LCD Monitors.

Dielectric strength: Max. DC 24V
Current: Max. 50mA

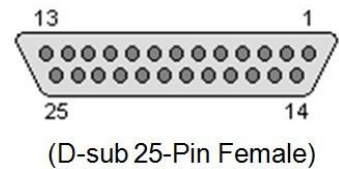

These ports are open collector ports and as such do not provide power to tally light circuits.

The pin outputs are defined as follows:

Pin No.	Signal name	Input/Output	Description of signal
1	Program 1	Open collector output	Tally output of input video Program 1
2	Program 2	Open collector output	Tally output of input video Program 2
3	Program 3	Open collector output	Tally output of input video Program 3
4	Program 4	Open collector output	Tally output of input video Program 4
5	Program 5	Open collector output	Tally output of input video Program 5
6	Program 6	Open collector output	Tally output of input video Program 6
13	GND	Ground	Ground
14	Preview 1	Open collector output	Tally output of input video Preview 1
15	Preview 2	Open collector output	Tally output of input video Preview 2
16	Preview 3	Open collector output	Tally output of input video Preview 3
17	Preview 4	Open collector output	Tally output of input video Preview 4
18	Preview 5	Open collector output	Tally output of input video Preview 5
19	Preview 6	Open collector output	Tally output of input video Preview 6

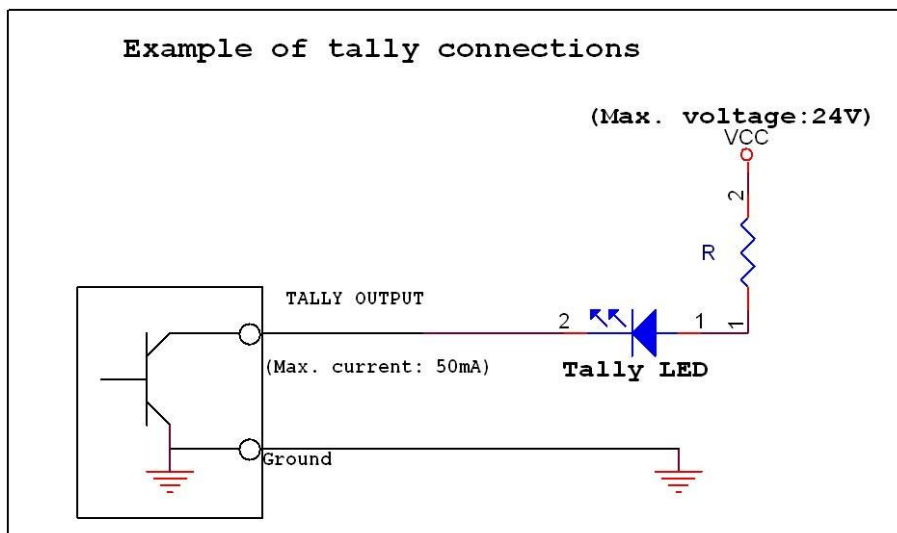

Example SE-2200 Set Up

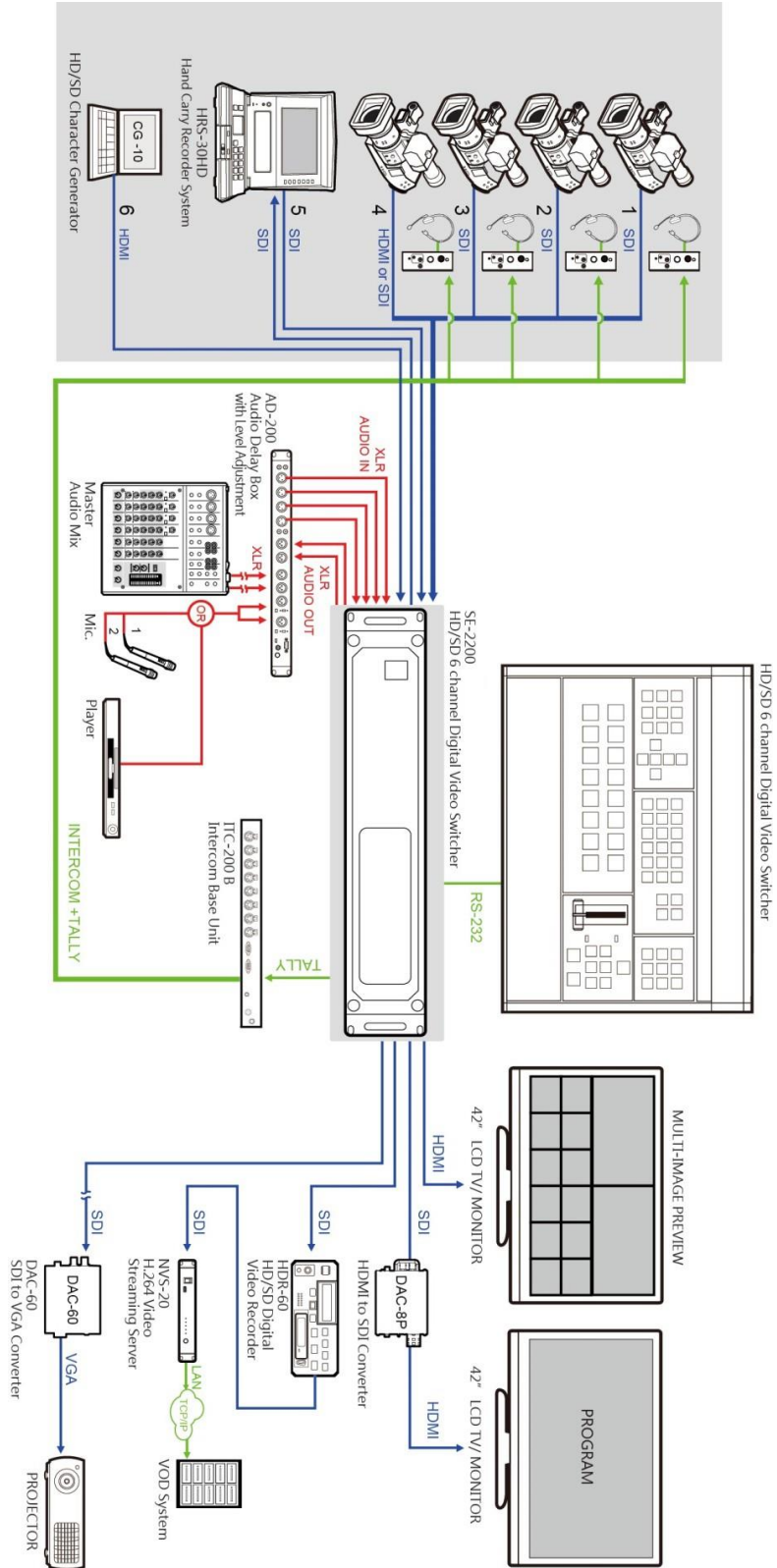

Dimensions

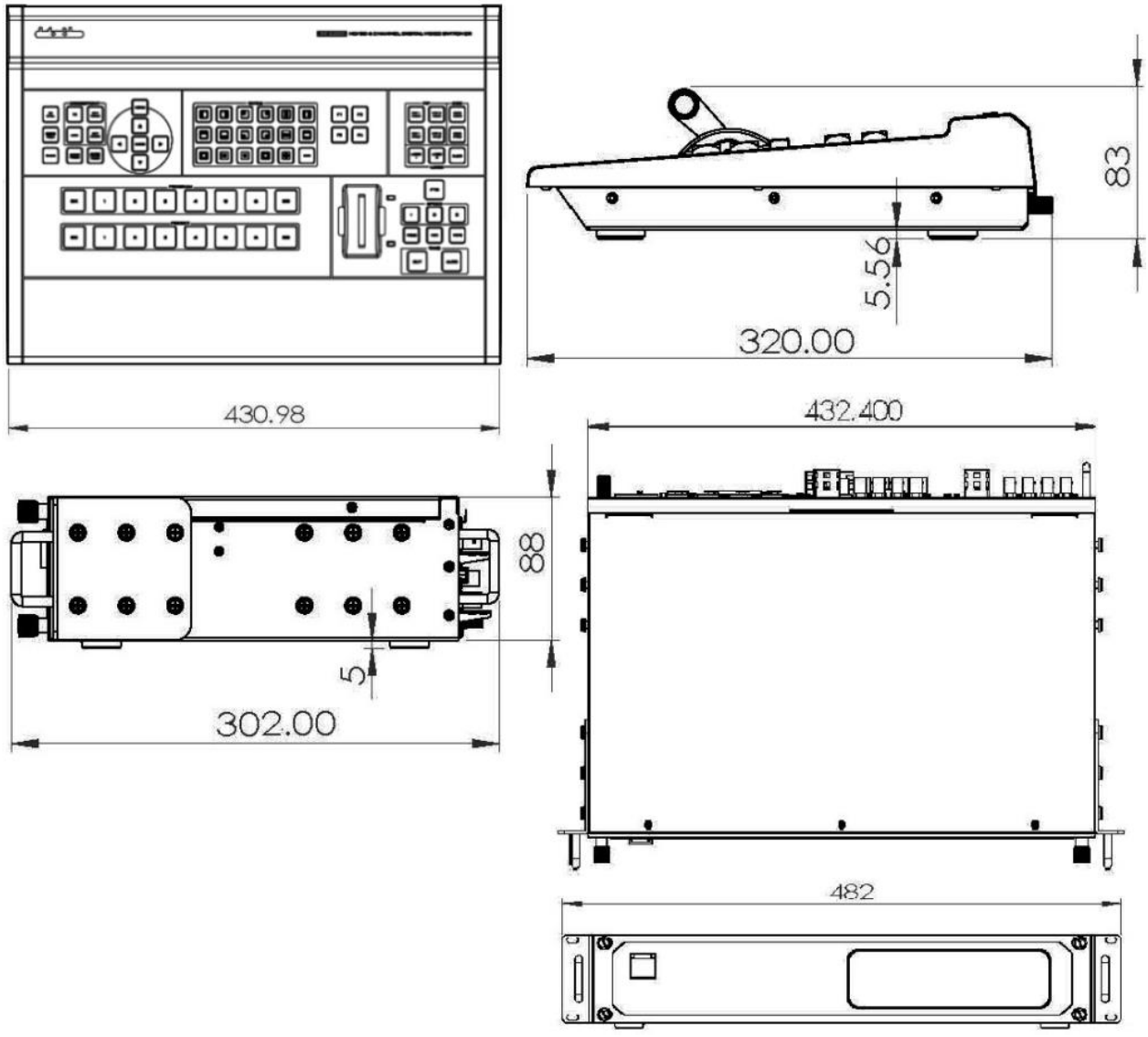

Specifications

Connections	
Total Video Inputs	Total 6 video inputs (6 SDI or 4 SDI + 2 HDMI)
Total Outputs	Total 6 SDI video outputs + 2 HDMI Multi view output
Multi view Out	HDMI
SDI Video Input	Max 6
HDMI Video Input	Max 2
Analog Audio Output	2 mono (1 stereo)
SDI Audio Output	SDI Embedded Audio
Analog Audio Input	4 mono (2 stereo)
Internal Frame Synchronizers	6 Frame Synchronizers
PGM Out	Up to 6
Multi view Out	HDMI x 2 (HDMI multi-view outputs format is 1080i.)
AUX output	up to 4 outputs
Control Panel Connection	RS-232
Tally Out	YES
GPI	YES
Software Updates	via Ethernet

Standards	
HD Format Support	1080i50, 1080i59.94, 1080i60, 720p50, 720p59.94, 720p60
Video Sampling	4:2:2 10 bit
Color Precision	4:2:2 10 bit
Color Space	SDI - YUV, HDMI - YUV / RGB
HDMI Input Resolutions for Computers	HDMI 1920x1080i/50Hz HDMI 1920x1080i/60Hz HDMI 1920x1080i/59.94Hz HDMI 1280x720p/50Hz
SDI Input Resolutions for Computers	1920x1080i/50Hz, 1920x1080i/60Hz, 1920x1080i/59.94Hz

Extras	
Downstream Key	1
Luma Key	1
Color Generators	BARS, COLOR BG
PIP	2
XPT	YES
Frame store	YES

Control Panel Compatibility	Use PC via Ethernet Control panel by RS-232
Input Voltage	DC12V
Power consumption	32W
DE-embedded audio sampling	48KHz
S/N : analog, digital to analog	> -72dB

Multi View Monitoring	
Number of Windows	2+6 (3 layout)
Tally	YES
Windows Source Labels	YES

Service & Support

It is our goal to make owning and using Datavideo products a satisfying experience. Our support staff is available to assist you to set up and operate your system. Contact your local office for specific support requests. Plus, please visit www.datavideo.com to access our FAQ section.

Datavideo Taiwan

Datavideo Technologies Co. Ltd
10F. No. 176, Jian 1st Rd., Chung Ho
District, New Taipei City 235, Taiwan,
R.O.C.
Tel: +886-2-8227-2888
Fax: +886-2-8227-2777
E-mail: service@datavideo.com.tw

Datavideo Europe

Datavideo Technologies Europe BV
Floridadreef 106
3565 AM Utrecht,
The Netherlands
Tel: +31-30-261-96-56
Fax: +31-30-261-96-57
E-mail: info@datavideo.nl

Datavideo United Kingdom

Datavideo UK Limited
Units 1 & 2 Waterside Business Park
Hadfield, Glossop, Derbyshire
SK13 1BE, UK
Tel: +44-1457 851 000
Fax: +44-1457 850 964
E-mail: sales@datavideo.co.uk

Datavideo USA

Datavideo Corporation
7048 Elmer Avenue.
Whittier, CA 90602,
U.S.A.
Tel: +1-562-696 2324
Fax: +1-562-698 6930
E-mail: sales@datavideo.us

Datavideo China

Datavideo Technologies China Co
101, NO.618, LiuYing Rd, Zhabei District,
Shanghai, China
Tel: +86 21-5603 6599
Fax: +86 21-5603 6770
E-mail: service@datavideo.cn

Datavideo Singapore

Datavideo Technologies (S) PTE Ltd
No. 178 Paya Lebar Road #06-03
Singapore 409030
Tel: +65-6749 6866
Fax: +65-6749 3266
E-mail: sales@datavideo.sg

Datavideo Hong Kong

Datavideo Hong Kong Ltd
G/F., 26 Cross Lane
Wanchai, Hong Kong
Tel: +852-2833-1981
Fax: +852-2833-9916
E-mail: info@datavideo.com.hk

Datavideo France

Datavideo France s.a.r.l
Cité Descartes 1, rue Albert Einstein
Champs sur Marne
774477-Marne la Vallée cedex 2
Tel: +33-1-60370246
E-mail: info@datavideo.fr

Datavideo India

Datavideo Technologies India Pvt Ltd
A-132, Sec-63, Noida-201307,
Uttar Pradesh (UP), India.
Tel: +91-0120-2427337
Fax: +91-0120-2427338
E-mail: sales@datavideo.in



Please refer to our website for update the latest version manual.
www.datavideo.com/Mixer+-+Switchers/SE-2200

datavideo
www.datavideo.com